



Matthew G. Bevin
Governor

COMMONWEALTH OF KENTUCKY
TRANSPORTATION CABINET
Frankfort, Kentucky 40622
www.transportation.ky.gov/

Greg Thomas
Secretary

March 6, 2019

CALL NO. 200
CONTRACT ID NO. 195067
ADDENDUM # 1

Subject: GRANT COUNTY, 041GR19D067-STP
Letting March 22, 2019

- (1) Revised - Special Notes - Pages 17-53 of 191
- (2) Revised - Material Summary - Pages 146-148 of 191
- (3) Revised - Proposal Bid Items - Pages 190-191 of 191
- (4) Revised - Delete Special Note - Pages 54-78 of 191
- (5) Revised - Plan Sheets - S1 (B00011N), S1 (B00013N), S2 (B00011N), S3 (B00014N), S4 (B00013N), S4 (B00014N), S5 (B00013N), S5 (B00014N), S6 (B00011N), S6 (B00013N), S6 (B00014N), and S12 (B00011N)

Proposal revisions are available at <http://transportation.ky.gov/Construction-Procurement/>.

If you have any questions, please contact us at 502-564-3500.

Sincerely,

A handwritten signature in cursive script that reads "Rachel Mills".

Rachel Mills, P.E.
Director
Division of Construction Procurement

RM:mr
Enclosures



An Equal Opportunity Employer M/F/D

SPECIAL NOTE FOR TRAFFIC CONTROL ON BRIDGE REPAIR CONTRACTS

Bundle 19.03.09

Grant County 06-10002.10 041B00013N

Grant County 06-10002.00 041B00014N

Grant County 06-10010.00 041B00011N

I. TRAFFIC CONTROL GENERAL

Except as provided herein, traffic shall be maintained in accordance with the 2012 standard specifications, section 112. The contractor will be responsible for developing and implementing the maintenance of traffic details with guidance through standard drawings and the MUTCD current editions. The developed traffic control plan must be approved by the Engineer prior to implementation. The contractor is expected to provide at a minimum the items listed in this note, however this note does not relieve the contractor of other items that may be necessary to comply with current standards. Except for the roadway and traffic control bid items listed, all items of work necessary to maintain and control traffic will be paid at the lump sum bid price to "Maintain and Control Traffic".

Contrary to section 106.01, traffic control devices used on this project may be new or used in new condition, at the beginning of the work and maintained in like new condition until completion of the work.

The contractor must notify the engineer and public information officer at least 14 calendar days prior to the beginning work. Please see the Special Note for Liquidated Damages for additional information.

II. TRAFFIC COORDINATOR

Furnish a traffic coordinator as per section 112. The traffic coordinator shall inspect the project maintenance of traffic, at least three times daily, or as directed by the engineer, during the contractor's operations and at any time a bi-directional lane closure or road closure is in place. The personnel shall have access on the project to a radio or telephone to be used in case of emergencies or accidents. The traffic coordinator shall report all incidents throughout the work zone to the engineer on the project. The contractor shall furnish the name and telephone number where the traffic coordinator can be contacted at all times.

III. SIGNS

The contractor is responsible for all signage during construction. The contractor shall adhere to the standard drawings and manual on uniform traffic control devices (MUTCD) for guidance. If, at any time, the engineer requests a change in the maintenance of traffic signage, the contractor shall implement the change within 8 hours. Failure to implement these changes within the required eight hours will result in liquidated damages of \$5,000 per day.

The contractor shall provide all detour signing needed for the bridge closure, if allowed in the

contract documents. All signing required will be incidental to the lump sum bid item “Maintain and Control Traffic”.

The department will not measure installation, maintenance, or removal for payment of any detour signage or standard construction signage, and will consider these incidental to “Maintain and Control Traffic”

Closure signs, detour signs, and bi-directional lane closure signs should be placed no sooner than two weeks prior to the closing of the bridge (when applicable) or placing lane closures. Wayfinding detour signs should be placed a maximum of 2 miles apart unless specified by the engineer. Signs shall be covered or removed within 24 hours of opening the bridge to traffic.

Road closed signs (when applicable) should be double signed and placed a minimum of 1500’, 1000’, and 500’ in advance of the closure, in addition to signage required by the MUTCD and standard drawings.

IV. TEMPORARY PAVEMENT STRIPING

For projects where road closures are allowed in the contract documents, it is not anticipated that temporary pavement striping will be needed since the bridge will be closed. However, if the contractor’s means and methods allows for need for temporary striping, conflicting pavement marking will be covered with 6” black removable tape. However, for bi-directional lane closures or if the plans call for a diversion, temporary striping will be required per the plans and MUTCD. Contrary to the standard specifications, no direct payment will be made for any temporary striping, pavement striping removal, or any other temporary striping item. If temporary striping is used, the contractor shall replace any temporary striping that becomes damaged or fails to adhere to the pavement before dark on the day of the notification. Liquidated damages shall be assessed to the contractor at a rate of \$500 per day for failing to replace temporary striping within this time limit.

V. PROJECT PHASING & CONSTRUCTION PROCEDURES

Project phasing shall be as directed by the plans, special notes, and the approved Traffic Control Plan prepared by the contractor. Maintain traffic over the bridge as long as possible. Once work on the structure begins that impacts traffic, ensure work progresses to minimize the effected time to the public. All materials that must be made specific for the project should be ordered and made prior to closure of the bridge or implementation of bi-directional lane closures so that delivery does not delay progress of the work, unless approved by the Engineer. If the bridge is reopened prior to safety devices being in place, an approved protective barrier wall shall be placed in accordance to the standard drawings. Contrary to standard specifications, no direct payment would be made for the barrier wall and will be considered incidental to “Maintain and Control Traffic”.

For projects which require an on-site diversion to be constructed to maintain traffic, the traffic control plan and project schedule prepared by the contractor shall include provisions such that traffic is not switched to the diversion until all materials that must be made specific for the

project are ordered and made so that use of the diversion is minimized, unless approved by the Engineer.

VI. PAVEMENT DROP-OFF

Less than two inches - no protection required. Warning signs should be placed in advance and throughout the drop-off area.

Two to four inches - plastic drums, vertical panels or barricades every 100 feet on tangent sections for speeds of 50 mph or greater. Cones may be used in place of plastic drums, panels and barricades during daylight hours. For tangent sections with speeds less than 50 mph and curves devices should be placed every 50 feet. Spacing of devices on tapered sections should be in accordance with the manual on uniform traffic control devices, current edition.

Greater than four inches - positive separation or wedge with 3:1 or flatter slope needed. If there is five feet or more distance between the edge of the pavement and the drop-off, then drums, panel, or barricades may be used. If the drop-off is greater than 12 inches, positive separation is strongly encouraged. If concrete barriers are used, special reflective devices or steady burn lights should be used for overnight installations.

For temporary conditions, drop-offs greater than four inches may be protected with plastic drums, vertical panels or barricades for short distances during daylight hours while work is being done in the drop-off area.

VII. VARIABLE MESSAGE SIGNS AND TEMPORARY TRAFFIC SIGNALS

At the direction of the Engineer, the contractor is expected to provide up to four (4) message boards for use at locations determined by the Engineer. These message boards are expected to be in place one week prior to the closure of the roadway and remain in place for the duration of the closure. The message boards will be paid for as per the standard specifications.

For projects that involve the use of lane closures, all lane closures shall be bi-directional. The contractor shall provide temporary traffic signals and all labor, materials, and incidentals needed to maintain bi-directional traffic for the project. For short term bi-directional lane closures, the use of flaggers in lieu of temporary traffic signals may be acceptable if approved by the Engineer.

VIII. BARRICADES

For projects which allow full closure, ensure a minimum of (4) type III barricades are used at each end of the bridge for a total of (8) type III barricades. Contrary to the standard specifications, no direct payment will be made for barricades but they will be included in the lump sum price for "Maintain and Control Traffic".

VIII. DETOUR AND ON SITE DIVERSIONS

For projects which allow a full closure of the bridge, or if necessary to detour trucks, the traffic control plan proposed by the contractor shall include a signed detour route for the road closure. The traffic control plan along with the proposed detour plan will be delivered to the engineer at the pre-construction meeting. The proposed detour route shall meet the following requirements:

- 1) Detour routes must remain at minimum on the same classification of roadway (i.e. AA, AAA, state, county, etc.) Unless written approval is obtained through the owner of the facility.
- 2) The contractor must coordinate with other projects along the detour route in order to avoid ongoing construction projects along those routes.
- 3) It may be determined that two detour routes would be needed if the first selected route cannot accommodate truck traffic. If this occurs, the contractor is expected to sign both detours per the standard drawings and MUTCD. Additional clarification signage between the detours may be needed at points where they diverge.
- 4) For projects that involve the use of bi-directional lane closures and the temporary lane width per the plans or as proposed by the contractor is less than 10 feet, the contractor shall be required to provide a signed detour for oversized vehicles.

The traffic control plan must be submitted and approved to allow for coordination of the public information officer with the closure notification. The public must be notified of the proposed detour route when they are notified of the closure, 2 weeks before closure. All time and expenses necessary for the development of the detour plan(s) will be incidental to the lump sum bid item "Maintain and Control Traffic".

For projects with an on-site diversion included in the construction, the preparation of traffic control plans for a detour and implementation of a detour will not be required, unless specified in the plans.

IX. PAYMENT

Unless listed as a bid item in the contract documents, payment will only be made for the following items:

1. Portable Changeable Message Boards Each
2. Maintain and Control Traffic Lump Sum

All other items needed to maintain traffic in accordance with these contract documents and the approved traffic control plan shall be considered incidental to Maintain and Control Traffic. These items include but are not limited to traffic signals, signs, barrier wall, crash cushions, temporary guardrail, temporary and permanent pavement striping, cones, barrels, flaggers, etc.

SPECIAL NOTE FOR PLACING BRIDGE OVERLAY APPROACH PAVEMENT

Bundle 19.03.09

Grant County 06-10002.10 041B00013N

Grant County 06-10002.00 041B00014N

Grant County 06-10010.00 041B00011N

I. DESCRIPTION

Perform all work in accordance with the Kentucky Transportation Cabinet, Department of Highway's 2012 Standard Specifications for Road and Bridge Construction and applicable Supplemental Specifications, the Standard Drawings, this Note, and the Contract Documents. Section references are to the Standard Specifications.

This work consists of the following:

1. Furnish all labor, materials, tools, and equipment.
2. Removal of existing abutment backfill, if needed.
3. Structural Granular Backfill, as needed.
4. Mill the existing pavement.
5. Place new DGA, asphalt base, and asphalt surface
6. Repair the roadway shoulders, if needed.
7. Provide Pavement Markings if needed.
8. Any other work specified as part of this contract.

II. MATERIALS

- A. Structural Granular Backfill.** See Section 8.05.11
- B. DGA.** See Section 302.
- C. Tack Coat.** This material shall be in accordance with the Standard Specifications.
- D. CL2 ASPH BASE 1.0D PG 64-22.** See Standard Specifications
- E. ASPHALT LEVEL AND WEDGE.** See Standard Specifications
- F. CL2 ASPH SURF 0.38D PG 64-22.** This material shall be in accordance with the Standard Specifications.
- G. GRANULAR EMBANKMENT.** This material shall be in accordance with the Standard Specifications.
- H. Pavement Striping.** See Section 713.

III. CONSTRUCTION – DECK, SUPERSTRUCTURE, AND FULL BRIDGE REPLACEMENTS

- A. Foundation Preparation.** For projects involving the removal and replacement of the asphalt and backfill behind the existing abutments and new abutments or end bents, the required excavation, Type IV geotextile fabric, 4" perforated pipe, and new Structural Granular Backfill as shown in Figure 1 as well as any excavation and grading needed to shape the bridge approaches to match the existing roadway template, will be paid for by the bid item for Foundation Preparation. See Special Provision 69 and the Standard Drawings regarding additional construction details as required.

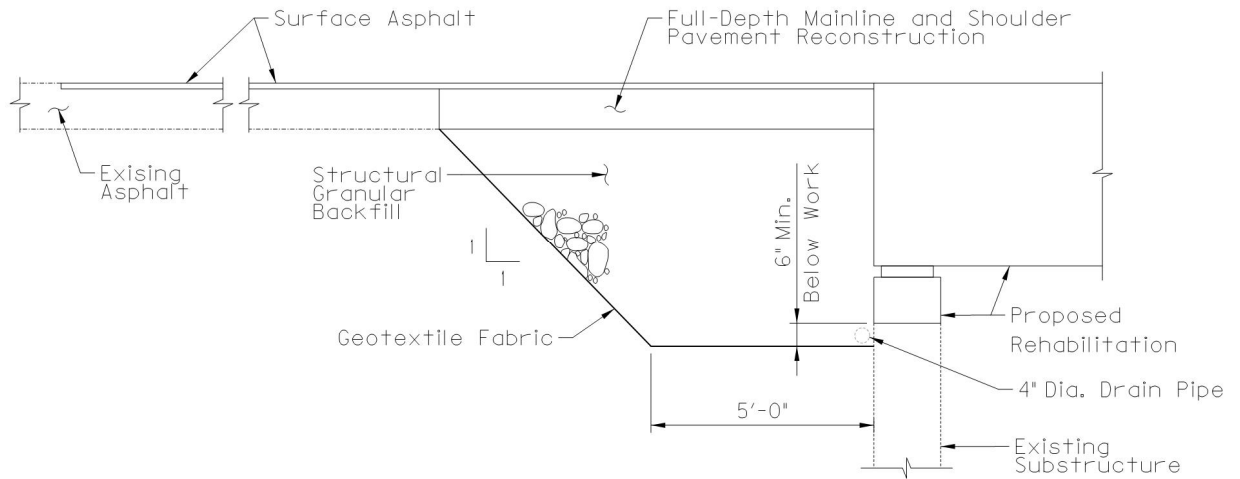

Figure 1: Detail showing proposed work for deck and superstructure replacements

- B. Remove Existing Asphalt Surface.** Remove the existing pavement material beyond the limits of full depth asphalt replacement to provide for a minimum of 1/4" new pavement surface from the bridge end extending approximately 25 feet, or as shown in the plans, into the approach pavement and across the width of the approach pavement. The Engineer shall determine the actual length and width of the milling depending on site conditions at each bridge approach. Mill the existing surface so that the new asphalt surface will match the elevation of the end of the full depth asphalt replacement and the bridge end. The Engineer shall approve the Contractor's plan for restoring the approach grade prior to the removal of the existing surface. Dispose of all removed material entirely away from the job site or as directed by the Engineer.
- C. Produce and Place New Asphalt Base.** Replace any full depth mainline and shoulder pavement removed as part of bridge backwall construction, superstructure replacement, or other work (if included in the Contract Documents) with a minimum of 8 inches of DGA, placed in two lifts of 4 inches each compacted and 8 inches of CL2 ASPH BASE 1.0D PG 64-22, placed in two lifts of 4 inches each compacted. Final elevation of the Asphalt Base at the approaches to match the width and new elevation of the riding surface on the bridge less the New Asphalt Surface to be placed. Shoulders shall receive identical treatment to the mainline pavement.
- D. Produce and Place New Asphalt Surface.** Apply an asphalt tack coat in accordance with Section 406. Produce and place the new 1 1/4" Asphalt Surface in accordance with Section 403 and compact under Option B. The new asphalt surface mixture required for this project shall be "CL2 ASPH SURF 0.38D PG 64-22". Place the new asphalt surface to smoothly connect the existing roadway grade at the end of the project, and/or the new abutment backwall.
- E. Granular Embankment for Guardrails.** When necessary to ensure compliance with standards, widen shoulders behind guardrail with granular embankment and cap with

DGA in accordance with plans or as directed by the Engineer. Remove existing topsoil as needed and place embankment in a manner to ensure proper compaction.

- F. Pavement Markings.** Pavement striping will be required to match the existing pavement striping on both approaches and the structure. Pavement striping shall be in accordance with applicable sections of the Standard Specifications and shall be incidental to the work. Raised pavement markers within the limits of the “Bridge Overlay Approach Pavement” shall be removed prior to the milling operation. The marker castings shall be cleaned and returned to the Engineer.

IV. CONSTRUCTION – OVERLAY PROJECTS

- A. Remove Existing Materials.** Remove the existing pavement material to provide for a minimum of 1¼” new pavement surface from the bridge end extending approximately 25 feet, or as shown in the plans, into the approach pavement and across the width of the approach pavement. The Engineer shall determine the actual length and width of the milling depending on site conditions at each bridge approach. Mill the existing surface so that the new asphalt surface will tie into the new armored edge, if applicable, and matches the elevation of the bridge end. The Engineer shall approve the Contractor’s plan for restoring the approach grade prior to the removal of the existing surface. Dispose of all removed material entirely away from the job site or as directed by the Engineer.
- B. Mainline and Shoulder Reconstruction.** Replace shoulders in kind at the approaches to match the width and new elevation of the riding surface on the bridge. Shoulders shall receive identical treatment to the mainline pavement.
- C. Produce and Place New Asphalt Surface.** Apply an asphalt tack coat in accordance with Section 406. Produce and place the new 1 ¼” Asphalt Surface in accordance with Section 403 and compact under Option B. The new asphalt surface mixture required for this project shall be “CL2 ASPH SURF 0.38D PG 64-22”. Place the new asphalt surface to smoothly connect the existing roadway grade at the end of the project and the bridge end.

For bridge decks specified to receive a new asphalt overlay as part of the work, place asphalt level and wedge and CL2 ASPH SURF 0.38D PG 64-22 as detailed in the plans to smoothly connect to the bridge approaches. If plans call for use of a waterproof membrane, this shall be addressed as a separate bid item.

- D. Granular Embankment for Guardrails.** When necessary to ensure compliance with standards, widen shoulders behind guardrail with granular embankment and cap with DGA in accordance with the plans or as directed by the Engineer. Remove existing topsoil as needed and place embankment in a manner to ensure proper compaction.
- E. Pavement Markings.** Pavement striping will be required to match the existing pavement striping on both approaches and the structure. Pavement striping shall be in accordance with applicable sections of the Standard Specifications and shall be incidental to the work. Raised pavement markers within the limits of the “Bridge

Overlay Approach Pavement” shall be removed prior to the milling operation. The marker castings shall be cleaned and returned to the Engineer.

V. MEASUREMENT

- A. Granular Embankment: The Department will measure the quantity in cubic yards. The Department will measure along the centerline to determine a linear foot of placement multiplied by a theoretical cross section of 12 square feet to achieve the quantity per side of the roadway.
- B. Bridge Overlay Approach Pavement: The Department will measure the quantity of in square yards. The Department will measure along the centerline from each end of the limits of the work as detailed on the plans to the point where the new pavement ties into the exiting pavement and across the width of the new pavement perpendicular to the centerline of the roadway.
- C. Foundation Preparation: See Section 603.

VI. PAYMENT

- A. Granular Embankment: Payment at the contract unit price per cubic yard of granular embankment is full compensation for granular embankment and DGA used for widening the shoulder for guardrail as directed. Variance of actual cross sectional quantities versus theoretical quantities will not be considered for additional payment.
- B. Bridge Overlay Approach Pavement: Payment at the contract unit price per square yard of is full compensation for removing existing pavement markers, mobilization of milling equipment, removing specified existing pavement material, reconstruct shoulders as needed, furnishing and installing the asphalt tack coat, producing and placing the new asphalt and DGA, and all incidental items necessary to complete the work within the specified pay limits as specified by this note and as shown in the Contract Documents.
- C. Foundation Preparation: See Section 603. Payment for Structural Granular Backfill to be incidental to Foundation Preparation.

<i>Code</i>	<i>Pay Item</i>	<i>Pay Unit</i>
02223	Granular Embankment	Cubic Yards
03304	Bridge Overlay Approach Pavement	Square Yards
08803	Foundation Preparation	Lump Sum

The Department will consider payment as full compensation for all work required.

SPECIAL NOTE FOR CONCRETE COATING

Bundle 19.03.09

Grant County 06-10002.10 041B00013N

Grant County 06-10002.00 041B00014N

Grant County 06-10010.00 041B00011N

I. DESCRIPTION

Perform all work in accordance with the Kentucky Transportation Cabinet, Department of Highways 2012 Standard Specifications for Road and Bridge Construction and applicable Supplemental Specifications, the Standard Drawings, this Note, and the Contract Documents. Section references are to the Standard Specifications.

This work consists of the following:

1. Furnish all labor, materials, tools, equipment, and incidental items necessary to complete the work.
2. Provide safe access to the bridge, in accordance with Section 107.01.01, for the Engineer to sound possible repair areas and for workers to complete the construction.
3. Repair cracks as applicable in accordance with the Special Note for Epoxy Injection Crack Repair.
4. Repair delaminated or spalled areas as applicable in accordance with the Special Note for Concrete Patching.
5. Apply Ordinary Surface Finish
6. Prepare the surfaces to receive coating.
7. Apply concrete coating.
8. Any other work as specified as part of this contract.

II. MATERIALS

One of the following coating systems shall be used:

<u><i>Manufacturer</i></u>	<u><i>Prime Coat</i></u>	<u><i>Finish Coat</i></u>
Sherwin Williams	Macropoxy 646	Acrolon 218 HS
PPG	Amerlock 2	Devoe Devflex HP
Carboline	Carboguard 890	Carbothane 133 HB
Tnemec	Elastogrip 151	Envirocrete 156

The finish product shall be opaque and satin or semi-gloss. The contractor must apply sufficient coats as required to achieve this goal. The finish coat shall be gray and will meet the following values:

	<u>L*</u>	<u>a*</u>	<u>b*</u>
Gray	74.94	-1.54	3.92

Furnish to the Engineer copies of the manufacturer's technical data sheets, installation guidelines, material safety data sheets, and other pertinent data at least two (2) days prior to beginning the work.

III. CONSTRUCTION

- A. Perform Concrete Repairs.** Repair concrete surface in accordance with the Special Note for Epoxy Injection Crack Repair and/or the Special Note for Concrete Patching Repair if included in the contract documents.
- B. Apply Ordinary Surface Finish.** Areas receiving epoxy injection, concrete patching, and other surface imperfections, including areas of minor cracking, should receive Ordinary Surface Finish in accordance with Section 601.03.18 of the Standard Specifications. Use mortar of the same cement and fine aggregate as the concrete patching, or as directed by the Engineer. Payment will be incidental to Concrete Sealing.
- C. Areas to Receive Concrete Coating:**
1. Every exposed surface above a point 6” below ground or fill line of abutments, wing walls, end bent and pier caps, pedestals, back walls, columns, and exposed footings.
 2. All exposed surfaces of concrete barrier walls, parapets, curbs, and plinths. Do not apply to the riding surface of the concrete deck.
 3. The underneath surfaces of slab overhangs outside of exterior girders and to the exterior side and bottom of exterior concrete girders, beams, and box beams.
- D. Prepare Concrete Surfaces for Repair.** All areas specified shall be pressure washed. Equip the pressure washers with calibrated gages and pressure regulators to ascertain and regulate water pressure. All equipment for pressure washing shall be operated at a minimum pressure of up 3,500 to 4,500 psi with 0 degree spinner tip and/or fan tips as determined by the engineer at the working location with a minimum flow rate of 3.5 gal/minute provided that these pressures do not damage any components of the structure. Pressure and flow rates shall be reduced to a level satisfactory to the Engineer should any damage occur due to power washing procedures. The washing wand must be approximately perpendicular to the washed surface and within a maximum of 12 inches of the surface. Wand extensions greater than 36 inches will be subject to Division of Construction approval. Pressure washing of any bridge element will proceed from top of wash area to bottom of wash area. Perform all pressure washing at temperatures above 40 degrees Fahrenheit.
- E. Apply Concrete Coating.** All areas specified shall have concrete coating applied to as specified after debris removal and power washing. New concrete shall be allowed to properly cure in accordance with the manufacturer’s recommendations prior to application. Use compressed air to remove any loose debris from the surfaces that are to be coated after power washing. All coatings shall be applied within manufacturers recommended dry film thickness range. Comply with KYTC “Standard Specifications

for Road and Bridge Construction” Section 614.03.02 and coatings supplier recommended conditions for application. Allow the surfaces to be coated to dry a minimum of 24 hours before any coating is applied. The coating must be applied with 72 hours of pressure washing. The coating must be applied to a clean and dry surface. All coating application shall be executed using brushes, rollers, etc. No spray application will be permitted.

The Department requires acceptance testing of samples obtained on a per-lot basis per-shipment. The Division of Materials shall perform acceptance testing. Test samples shall be taken at the Contractor’s paint storage site. Department personnel shall perform sampling. Allow (10) working days for testing and approval of the sampled paint. It is the Contractor’s responsibility to maintain an adequate inventory of approved paint. The Department shall assume no responsibility for lost work due to rejection of paint or approved paint subsequently found to be defective during the application process. Perform all concrete coating application at temperatures above 40 degrees Fahrenheit or in accordance with manufactures specifications.

IV. MEASUREMENT

The Department will measure the quantity in square feet. The Department will not measure preparation of the site for the Engineer’s access or removal and reapplication of coatings that do not satisfy the Engineer’s approval for payment and will consider them incidental to “Concrete Coating”.

V. PAYMENT.

The Department will make payment for the completed and accepted quantities of concrete coating under the following:

<u>Code</u>	<u>Pay Item</u>	<u>Pay Unit</u>
24982EC	Concrete Coating	Lump Sum

The plans may show an estimate quantity in square feet. The Department will consider payment as full compensation for all work required as described in this note.

SPECIAL NOTE FOR EROSION PREVENTION AND SEDIMENT CONTROL

Bundle 19.03.09

Grant County 06-10002.10 041B00013N
Grant County 06-10002.00 041B00014N
Grant County 06-10010.00 041B00011N

When required, the Contractor shall be responsible for filing the Kentucky Pollution Discharge Elimination System (KPDES) KYR10 permit Notice of Intent (NOI) with the Kentucky Division of Water (DOW) and any KPDES local Municipal Separate Storm Sewer System (MS4) program that has jurisdiction. The NOI shall name the contractor as the Facility Operator and include the KYTC Contract ID Number (CID) for reference.

The Contractor shall perform all temporary erosion/sediment control functions including: providing a Best Management Practice (BMP) Plan, conducting required inspections, modifying the BMP plan documents as construction progresses and documenting the installation and maintenance of BMPs in conformance with the KPDES KYR10 permit effective on August 1, 2009 or a permit re-issued to replace that KYR10 permit. This work shall be conducted in conformance with the requirements of Section 213 of KYTC 2012 Department of Highways, Standard Specifications for Road and Bridge Construction.

The Contractor shall perform all final seeding and protection, in accordance with the plans and Section 212 of the KYTC 2012 Department of Highways, Standard Specifications for Road and Bridge Construction.

Contrary to Section 213.03.03, paragraph 2, the Engineer shall conduct inspections as needed to verify compliance with Section 213 of KYTC 2012 Department of Highways, Standard Specifications for Road and Bridge Construction. The Engineer's inspections shall be performed a minimum of once per month and within seven days after a storm of ½ inch or greater. Copies of the Engineer's inspections shall not be provided to the contractor unless improvements to the BMP's are required. The contractor shall initiate corrective action within 24 hours of any reported deficiency and complete the work within 5 days. The Engineer shall use Form TC 63-61 A for this report. Inspections performed by the Engineer do not relieve the Contractor of any responsibility for compliance with the KPDES permit. If corrections are not made within the 5 days specified, liquidated damages will apply at the rate specified in the Liquidated Damages note in the contract.

Contrary to Section 212.05 and 213.05, bid items for temporary BMPs and items for permanent erosion control will not be listed and will be replaced with one lump sum item for the services. Payment will be pro-rated based on the Project Schedule as submitted by the Contractor and as agreed to by the Engineer.

The contractor shall be responsible for applying "good engineering practices". The contractor may use any temporary BMPs and permanent BMPs that fall within the guidance of the 2012 Standard Specifications, KYTC's Best Management Practices manual, and with the approval of the KYTC Engineer.

The contractor shall provide the Engineer copies of all documents required by the KPDES permit at the time they are prepared.

The contractor shall be responsible for the examination of the soils to be encountered and make his own independent determination of the temporary BMPs that will be required to accomplish effective erosion prevention and sediment control.

The Contractor shall be responsible for filing the KPDES permit Notice of Termination (NOT) with the Kentucky DOW and any local MS4 program that has jurisdiction. The NOT shall be filed after the Engineer agrees that the project is stabilized or the project has been formally accepted.

SPECIAL NOTE FOR BRIDGE RESTORATION AND WATERPROOFING WITH CONCRETE OVERLAYS

Bundle 19.03.09

Grant County 06-10002.10 041B00013N

Grant County 06-10002.00 041B00014N

Grant County 06-10010.00 041B00011N

I. DESCRIPTION. Perform all work in accordance with the Kentucky Transportation Cabinet, Department of Highway’s 2012 Standard Specifications for Road and Bridge Construction and applicable Supplemental Specifications, the Standard Drawings, this Note, and the attached detail drawings. Section references are to the Standard Specifications.

This work consists of the following:

- (1) Furnish all labor, materials, tools, and equipment;
- (2) Machine prep the existing slab for bridge without existing overlays ~ or ~ Remove the existing overlay for bridges with overlays
- (3) Complete full-depth and partial depth repairs as directed by the Engineer;
- (4) Repair/replace damaged and corroded reinforcing bars;
- (5) Place new concrete overlay and epoxy-sand slurry in accordance with Section 606;
- (6) Complete asphalt approach pavement;
- (7) Maintain and control traffic; and
- (8) Any other work specified as part of this contract.

All construction will be in accordance with Section 606 unless otherwise specified.

II. MATERIALS.

A. Latex Concrete. See Section 606.03.17.

B. Class “M” Concrete. Use either “M1” or “M2”. See Section 601.

C. Bituminous Asphalt. Use CL2 ASPH SURF 0.38D PG64-22.

D. Epoxy-Sand Slurry. See Section 606.03.10.

III. CONSTRUCTION.

A. For bridges which do not have an existing overlay:

Machine prep of existing slab. Remove concrete from existing slab to a depth of at least ¼” below the existing surface, and remove all patches completely, in accordance with the requirements of Section 606.03.03. This work is incidental to pay item “Machine Preparation of Slab”

~ or ~

A. For bridges which have an existing overlay:

Remove Existing Overlay. In addition to Section 606.03.03, totally remove the existing asphalt, concrete, or foreign overlay by grinding or scarifying the deck to a depth slightly below or equal to the original bridge slab surface or to the depth as shown in the plans. Machine preparation of the existing slab to a depth of at least ¼” below the existing surface is NOT required. When removal of an existing overlay is a

pay item, no payment will be allowed for “Machine Preparation of Existing Slab”. This work is incidental to the pay item “Removal of Epoxy, Asphalt, or Foreign, Overlay”

- B. Partial Depth Slab Repair and Latex Overlay.** Remove areas determined to be unsound by the Engineer via hydrodemolition or via hand held jackhammers weighing less than 45lbs in accordance with Section 606.02.10 D. Repair/Replace all damaged or severely corroded reinforcing bars prior to partial depth repair operation. The Department will not measure material removal and will consider this work incidental to the bid item “PARTIAL DEPTH PATCHING”. Mix and place Latex Modified Concrete Overlay in accordance with Sections 606.03.08 and 606.03.17.
- C. Asphalt Approach Pavement.** See the the Special Note for Bridge Overlay Approach Pavement for Construction, Measurement, and Payment.
- D. Surface Texturing.** Texture the concrete surface of the overlay in accordance with Section 609.03.10.

IV. MEASUREMENT. See Section 606 and the following:

- A. Latex Modified Concrete for Overlay.** The Department will measure the quantity in cubic yards using the theoretical volume.
- B. Latex Modified Concrete for Partial Depth Patching and variable thickness of Overlay.** The Department will measure the quantity in cubic yards by deducting the theoretical volume of bridge deck overlay (LMC) from the total volume (as indicated by the batch quantity tickets) of Concrete required to obtain the finished grade shown on the Plans or established by the Engineer.
- C. Removal of Epoxy, Asphalt, or Foreign Overlay.** See Section 606.
- D. Machine Preparation of Slab.** See Section 606.
- E. Blast Cleaning.** See Section 606.
- F. Epoxy Sand Slurry.** See Section 606.
- G. Steel Reinforcement.** The Department will measure any reinforcing steel necessary for the partial or full depth patch in pounds, which shall include all labor, equipment, and material needed to complete this work.

V. PAYMENT. See Section 606 and the following:

- A. Latex Modified Concrete for Overlay.** The Department will make payment for the Latex Modified Concrete under bid item #08534 “CONCRETE OVERLAY – LATEX” for the quantity in cubic yards complete in place.
- B. Latex Modified Concrete for Partial Depth Patching and variable thickness of Overlay.** The Department will make payment for the Partial Depth Patching under bid item #24094EC “PARTIAL DEPTH PATCHING”. Payment will be for the quantity per cubic yard complete in place.
- C. Removal of Epoxy, Asphalt, or Foreign Overlay.** See Section 606.
- D. Machine Preparation of Slab.** See Section 606.
- E. Blast Cleaning.** See Section 606.
- F. Epoxy Sand Slurry.** See Section 606.

G. Steel Reinforcement. The Department will make payment for steel reinforcement, if necessary, under bid item #08150 “STEEL REINFORCEMENT”. Payment will be at the unit price per pound.

SPECIAL NOTE FOR CONCRETE PATCHING REPAIR

Bundle 19.03.09

Grant County 06-10002.10 041B00013N

Grant County 06-10002.00 041B00014N

Grant County 06-10010.00 041B00011N

These Notes or designated portions thereof, apply where so indicated on the plans, proposals or bidding instruction.

- I. DESCRIPTION.** Perform all work in accordance with the Department's 2012 Standard Specifications, and applicable Supplemental Specifications, the attached sketches, and these Notes. Section references are to the Standard Specifications.

This work consists of: (1) Furnish all labor, materials, tools, and equipment; (2) Remove existing spalled/delaminated concrete; (3) Prepare the existing surface for concrete patching; (4) Place hook fasteners and welded wire fabric over surfaces to be repaired (where applicable); (5) Apply concrete patching as specified by this note and as shown on the attached detail drawings; (6) Finish and cure the new Concrete Patches; (7) Maintain & control traffic; and, (8) Any other work specified as part of this contract.

II. MATERIALS.

- A. Class "M" Concrete.** Use either "M1" or "M2". See Section 601.
- B. Steel Reinforcement.** Use Grade 60. See Section 602
- C. Welded Steel Wire Fabric (WWF).** Conform to Section 811
- D. Hook Fasteners.** Use commercial grade galvanized hook fasteners. Minimum 3/16" diameter.

III. CONSTRUCTION.

- A. Concrete Removal and Preparation.** The Contractor, as directed by the Engineer shall locate and remove all loose, spalled, deteriorated and delaminated concrete. Sounding shall be used to locate delaminated areas. Care shall be exercised not to damage areas of sound concrete or reinforcing steel during concrete removal operations. Concrete removal shall be in accordance with a sequence approved by the Engineer.

Concrete removal shall be accomplished by chipping with hand picks, chisels or light duty pneumatic or electric chipping hammers (not to exceed 15 lbs.). Remove all deteriorated loose concrete to a minimum depth of 4". When reinforcing steel is exposed, concrete removal shall continue until there is a minimum 3/4 inch clearance around the exposed reinforcing bar. Care shall be taken to not damage bond to adjacent non-exposed reinforcing steel during concrete removal processes. Unless specifically *directed by the Engineer*, depth of removal shall not exceed 6 inches.

The perimeter of all areas where concrete is removed shall be tapered at an approximately 45° angle, except that the outer edges of all chipped areas shall be

saw cut to minimum depth of 1 inch to prevent featheredging unless otherwise approved by the Engineer.

After all deteriorated concrete has been removed; the repair surface to receive concrete patching shall be prepared by abrasive blast cleaning. Abrasive blast cleaning shall remove all fractured surface concrete and all traces of any unsound material or contaminants such as oil, grease, dirt, slurry, or any materials which could interfere with the bond of freshly placed concrete.

The Contractor shall dispose all removed material off State Right Of Way in an approved site.

- B. Steel Reinforcement.** All corroded reinforcing steel exposed during concrete removal shall have corrosion products removed by abrasive grit blasting or wire brush whichever is more appropriate. Furnish for replacement, as directed by the Engineer, additional linear feet of steel reinforcing bars ½” diameter by 20-foot lengths. Place these bars in areas deemed by the Engineer to require additional reinforcement. Field cutting and bending is permitted. Deliver unused bars to the nearest County Maintenance Barn. Payment will be made in accordance with Section 602.

Reinforcing steel displaying deep pitting or loss of more than 20 percent of cross-sectional area shall be removed and replaced. Such bars shall be placed in accordance with the recommendations of ACI 506R, Sections 5.4 and 5.5. In particular, bars shall not be bundled in lapped splices, but shall be placed such that the minimum spacing around each bar is three times the maximum aggregate size to allow for proper encapsulation with concrete patching.

Intersecting reinforcing bars shall be tightly secured to each other using tie wire and adequately supported to minimize movement during concrete placement. Welded wire fabric (WWF) shall be provided when shown on the attached sketches and at each repair area larger than 1 square foot if the depth of the repair exceeds 3 inches from the original dimension of the repaired member. Sheets of adjoining WWF shall be lapped by at least one and one-half spaces at all intersections, in both directions, and be securely fastened. WWF fabric shall be supported no closer than ½ inch to the prepared concrete surface and shall have a minimum concrete cover of 1.5 inches.

WWF shall be fastened to preset anchors on a grid not more than 12 inches square. Large knots of tie wire which could result in sand pockets and voids during patching shall be avoided.

- C. Hook Fasteners.** Hook fasteners shall be positioned at the spacing as stated above or as directed by the Engineer. Any given area shall have a minimum of four anchors. The WWF shall not move or deform excessively during concrete patching. Maximum hook fastener spacing shall not exceed 2 feet on a grid pattern over the entire repair area.

Hook fasteners shall be of commercial grade galvanized steel with a minimum diameter of 3/16". They may be mechanically set or grouted, as approved by the Engineer.

The Department will randomly select hook fasteners to be tested to verify pullout force is sufficient. If any anchors fail to meet the minimum acceptable pullout value, corrective measures shall be taken by the Contractor and further testing will be conducted.

- D. Class M Concrete.** Place and finish the new concrete for the patching area as shown on the attached detail drawings, or as directed by the Engineer. The Engineer shall approve the Contractor's method of placing and consolidating the concrete prior to the beginning of this operation.

- E. Curing.** On completion of finishing operation, patching concrete shall immediately be prevented from drying out and cracking by fogging, wetting, and/or any appropriate method approved by the Engineer. See Section 501.03.15.

Each Contractor submitting a bid for this work shall make a thorough inspection of the site prior to submitting his bid and shall thoroughly familiarize himself with existing conditions so that the work can be expeditiously performed after a contract is awarded. Submission of a bid will be considered evidence of this inspection having been made. Any claims resulting from site conditions will not be honored by the Department. Quantities given are approximate. The quantity for "Concrete Patching Repair" shall be bid with the contingency that quantities may be increased, decreased, or eliminated by the Engineer. Dispose of all removed material entirely away from the job site as approved by the Engineer. This work is incidental to the contract unit price for "Concrete Patching Repair".

IV. MEASUREMENT

- A. Concrete Patching Repair.** The Department will measure the quantity per square feet of each area restored. Double payment will not be made on both faces of corner repairs.
- B. Steel Reinforcement.** See Section 602.
- C. Welded Wire Fabric & Hook Fasteners.** Welded Wire Fabric and Hook Fasteners will not be measured for payment, but shall be considered incidental to "Concrete Patching Repair".

V. PAYMENT

- A. Concrete Patching Repair.** Payment at the contract unit price per square feet is full compensation for the following: (1) Furnish all labor, materials, tools, equipment; (2) preparation of specified areas including removing and disposing of specified existing materials; (3) place, finish, and cure new concrete patches; and (4) all incidentals necessary to complete the work as specified by this note and as shown on the attached detail drawings.
- B. Steel Reinforcement.** See Section 602.
- The Department will consider payment as full compensation for all work required by these notes and detail drawings.

SPECIAL NOTE FOR DISTRIBUTED GALVANIC ANODES

Bundle 19.03.09

Grant County06-10002.10041B00013N

Grant County06-10002.00041B00014N

Grant County06-10010.00041B00011N

I. DESCRIPTION

Perform all work in accordance with the Kentucky Transportation Cabinet, Department of Highways 2012 Standard Specifications for Road and Bridge Construction and applicable Supplemental Specifications, the Standard Drawings, this Special Note, and the Contract Documents. Section references are to the Standard Specifications.

The work under this section shall consist of supply, installation, and quality control services for an alkali-activated zinc embedded galvanic corrosion protection system. The work includes preparation of submittal documents, verification and correction of electrical continuity, and making low-voltage electrical connections between the anodes and the existing reinforcing as shown on the drawings.

II. REFERENCES

- A. ACI 222R Protection of Metals in Concrete Against Corrosion
- B. ASTM B6 Standard Specification for Zinc
- C. ASTM B69 Standard Specification for Rolled Zinc
- D. ASTM B418 Standard Specification for Cast and Wrought Galvanic Zinc Anodes

III. MATERIALS

- A. The basis of design galvanic anode system is the Galvanode DAS distributed anode system supplied by Vector Corrosion Technologies, or approved equal.
- B. The embedded galvanic anode system shall have sufficient mass of sacrificial metal to produce galvanic current for twenty (20) years as calculated using Faradays Law. The system shall be designed to deliver a galvanic current density of at least 0.75 mA/SF of reinforcing steel surface area. Anode life is calculated using an efficiency factor and utilization factor of 0.9.
- C. Galvanic anode units shall be alkali-activated high-purity zinc encased in a mortar shell with pH greater than 14 with an internal alkali-resistant reinforcing mesh and wicking material that completely surrounds the zinc core. The anode units shall have nominal cross-section dimension of 1.25-inch diameter and nominal 6.5-foot length, or as indicated on the drawings.
- D. Two steel electrical connection wires shall be provided at each end of the anodes.
- E. The anode units shall contain at least 0.6 lb. of high-purity zinc per lineal foot of anode and shall contain no constituents that are corrosive to reinforcing steel as per ACI 222R such as chlorides, sulfates, bromides, or other halides.
- F. The zinc anode shall contain a steel core and shall be manufactured in compliance with ASTM B 418 Type II (Z13000) and ASTM B69 Rolled Special High Grade Zinc

(Z13004) using zinc in compliance with ASTM B6 Special High Grade (Z13001) with iron content less than 15 ppm.

IV. CONSTRUCTION

A. Submittals

The Contractor shall submit installation shop drawings and product data for the galvanic anode system. Shop drawings shall identify:

- a. The quantity and length of anodes located on each individual element, provide details and notes for connection of anodes to the existing reinforcing. Any changes to locations of anodes made during installation shall be identified and included on an as-built drawing.
- b. The high-purity zinc anode contains an alkali-activated mortar with a pH of 14 or greater.
- c. The anode unit does not contain any corrosive constituents detrimental to reinforcing steel, e.g. chloride, sulfate, bromide, etc.
- d. Proven track record of the anode technology showing satisfactory field performance with a minimum of three projects of similar size and application.
- e. Independent third-party evaluation of the anode technology, e.g. Hitec, Concrete Innovations Appraisal Service, BRE, etc.

B. Personnel

- a. Contractor shall enlist and pay for the services of a cathodic protection technician (CPT) working under the direction of a cathodic protection specialist (CPS) certified by NACE International with documented experience in design and installation Quality Control of cathodic protection systems for reinforced concrete. The CPT shall be provided by the anode Manufacturer. CPT shall have a minimum of five years of documented experience installing cathodic protection systems for reinforced concrete.
- b. The contractor shall coordinate its work schedule with the designated CPT to allow for installation training during project startup and initial anode installation.
- c. The CPT shall be responsible for training the contractor's employees and State personnel in the following areas:
 - i. Anode storage and handling safety precautions;
 - ii. Verification of reinforcing steel electrical continuity and electrical continuity corrections;
 - iii. Anode installation process;
- d. The CPT shall prepare and submit to the Contractor a letter report certifying that the installation training has been completed containing the date(s) when training occurred, the names of personnel trained, and that the individuals demonstrated competency in the various aspects of the installation and quality control procedures.

C. Surface Preparation

- a. Remove all deteriorated concrete to the extents detailed on the plans.
- b. Thoroughly clean concrete surface by abrasive blasting, water blasting or similar approved methods to remove all oil, grease, dirt, loose concrete, and any other material that would prevent proper bonding prior to installing the galvanic anode

system.

- c. Sandblast exposed reinforcing steel surfaces to SSPC-SP6 Commercial Blast Cleaning / NACE No. 3 before installing the galvanic anode system.

D. Electrical Continuity

- a. The existing reinforcing steel shall be confirmed to be electrically continuous prior to anode installation. The Contractor shall confirm electrical continuity of the reinforcing steel by conducting quality control tests in the presence of the Engineer using a voltmeter with a minimum impedance of 10 Mohm.
- b. Existing reinforcing shall be fully exposed and cleaned for continuity testing in at least ten (10) locations per element. These test locations are often used for tying anodes to the reinforcing network. At a minimum, test locations should be located on either end of each row of anodes, and intermediate locations shall be spaced not more than fifteen (15) feet along each row of anodes. In the event discontinuous steel is located, more test locations/openings may be required.
- c. A resistance measurement between two test locations less than or equal to 1.0 ohm shall be considered continuous.
- d. A voltage difference between two test locations less than or equal to 1.0 mV shall be considered continuous.
- e. Any discontinuous steel identified may be corrected by tying the reinforcing steel with uncoated steel wire to adjacent continuous steel, resistance welding the intersections of bars if approved by the Engineer, or welding a solid steel wire or bar between the discontinuous steel and adjacent continuous steel.
- f. All reinforcing steel connections shall receive a coat of 100% solids, non-conductive epoxy such that no wire or brazing material will be in contact with the concrete when placement is complete. The contractor shall verify continuity between the connections and the ties prior to coating with epoxy.
- g. Continuity corrections shall be verified by the Engineer.

E. Anode Installation

- a. Anodes shall be installed such that there is at least 1 inch of concrete cover.
- b. The new reinforcing in the encasement is not intended to be electrically connected to the anode system.
- c. Electrical connections between the galvanic anodes and the existing reinforcing steel shall be completed using uncoated steel wire and/or stainless steel split-bolt fasteners where applicable.
- d. The Contractor shall test and verify electrical continuity between the existing reinforcing steel and galvanic anodes.
- e. Electrical continuity of the anodes and existing reinforcing steel network shall be confirmed by the Engineer prior to form installation.
- f. Any wire connections between steel and other metals, such as copper, must be electrically isolated from the concrete electrolyte using medium or heavy-walled adhesive-lined heat shrink tubing, waterproof rubber electrical tape, or encapsulated with 100% solids epoxy.

V. PAYMENT

Payment for materials, installation, and all incidental items necessary to complete the work in

accordance with this Special Note and as shown on the attached detail drawing(s) shall be incidental to Item 8150 Steel Reinforcement.

SPECIAL NOTE FOR REPLACING EXPANSION DAMS AND/OR INSTALLING ARMORED EDGES FOR CONCRETE BRIDGES

Bundle 19.03.09

Grant County SYP 06-10010.00 041B00011N

I. DESCRIPTION

Perform all work in accordance with the Kentucky Transportation Cabinet, Department of Highway's current Standard Specifications for Road and Bridge Construction and applicable Supplemental Specifications, the Standard Drawings, this Note, and the attached detail drawings. Section references are to the Standard Specifications.

This work consists of the following: (1) Furnish all labor, materials, tools, and equipment; (2) Remove the existing concrete, expansion devices, and bridge ends; (3) Install armored edges and new concrete as specified and in accordance with the attached detail drawings; (4) Maintain and control traffic; and (5) Any other work specified as part of this contract.

II. MATERIALS

- A. Class "M" Concrete.** Use either "M1" or "M2". See Section 601.
- B. Structural Steel.** Use new, commercial grade steel suitable for welding. The Engineer will base acceptance on visual inspection. See Standard Drawing BJE-001, current edition.
- C. Stud Anchors.** The armored edge stud anchors are ¾" x 6" embedded stud shear connectors conforming to ASTM A108, Grade 1015 (Nelson Studs or equal).
- D. Steel Reinforcement.** Use Grade 60. See Section 602.
- E. Epoxy Bond Coat.** See Section 511.

III. CONSTRUCTION

- A. Remove Existing Materials.** Remove the existing expansion dam/bridge end and specified areas of concrete as shown on the attached sketches. Remove debris and/or expansion joint filler as directed by the Engineer. Dispose of all removed material entirely away from the job site. This work is incidental to the contract unit price for "Expansion Joint Replacement" or "Armored Edge for Concrete". Clean and leave all existing steel reinforcement encountered in place.
- B. Place New Concrete and Armored Edges.** After all specified existing materials have been removed; place new armored edges to match the grade of the proposed overlay or to match the original grade (See attached detail drawings). Place the new Class "M" concrete to the scarified grade and finish to receive the new overlay or place the new Class "M" concrete to the original grade and finish with broom strokes drawn transversely from curb to curb.

All new structural steel shall be cleaned and painted with two coats of commercial primer paint red orange in color, except that the surfaces to come in contact with concrete are not to be painted.

Blast clean all areas of existing concrete and structural steel to come in contact with new concrete until free of all laitance and deleterious substances immediately prior to the placement of the Class "M" Concrete. The surface areas of existing concrete to come in contact with the new Class "M" Concrete are to be coated with an epoxy bond coat immediately prior to placing new concrete in accordance with Section 511. The interfaces of the new and old concrete shall be as nearly vertical and horizontal as possible.

- C. Additional Steel Reinforcement.** Furnish for replacement, as directed by the Engineer, 800 linear feet of steel reinforcing bars ½" diameter by 20' lengths. Place these bars in areas deemed by the Engineer to require additional reinforcement. Field cutting and bending is permitted. Do not place any additional steel reinforcement above the height of the top row of Nelson studs on the armored edges. Ensure that all exposed steel reinforcement is tied in accordance with Section 602.03.04 prior to pouring the new Class "M" concrete. Deliver unused bars to the Local County Maintenance Barn. Payment will be made in accordance with Section 602.
- D. Stage Construction.** If installation of concrete and armored edges in two (or more if specified) stages is necessary. Join the armored edges at or near the centerline of the roadway or lane line, field weld, and grind smooth.
- E. Shop Plans.** Shop plans will not be required. The Contractor is responsible for obtaining field measurements and supplying properly sized materials to complete the work.

IV. MEASUREMENT

- A. Armored Edge for Concrete.** The Department will measure the quantity in linear feet from gutterline to gutterline along the face of the bridge end.
- B. Steel Reinforcement.** See Section 602.

V. PAYMENT

- A. Armored Edge for Concrete.** Payment at the contract unit price per linear foot is full compensation for removing specified existing materials, furnishing and installing the new armored edges, concrete and all incidental items necessary to complete work (except the overlay material) within the specified pay limits as specified by this note and as shown on the attached detail drawings.
- B. Steel Reinforcement.** See Section 602.

The Department will consider payment as full compensation for all work required by this note and the attached detail drawings.

SPECIAL NOTE FOR ELIMINATING TRANSVERSE JOINTS ON BRIDGES

Bundle 19.03.09

Grant County 06-10010.00 041B00011N

I. DESCRIPTION

Perform all work in accordance with the Kentucky Transportation Cabinet, Department of Highway's current Standard Specifications for Road and Bridge Construction and applicable Supplemental Specifications, the Standard Drawings, this Note, and the attached detail drawings. Section references are to the Standard Specifications.

This work consists of the following:

- (1) Furnish all labor, materials, tools, and equipment.
- (2) Remove existing concrete to eliminate the transverse joint.
- (3) Install additional steel reinforcement and new concrete as specified and in accordance with the attached detail drawings.
- (4) Maintain and control traffic.
- (5) Any other work specified as part of this contract.

II. MATERIALS

- A. Class "M" Concrete.** Use either "M1" or "M2". See Section 601.
- B. Steel Reinforcement.** Use Grade 60. See Section 602.
- C. Epoxy Bond Coat.** See Section 511 and 826.

III. CONSTRUCTION

- A. Remove Existing Materials.** Remove the existing transverse joints, joint filler, and specified areas of concrete as shown on the attached detail drawings or as directed by the Engineer. Dispose of all removed material entirely away from the job site. Do not disturb the tops of the beams. This work is incidental to the contract unit price for "Eliminate Transverse Joint".

Clean and leave all existing steel reinforcement encountered in place. Damaged steel reinforcement will be repaired/replaced as directed by the Engineer at no additional cost to the Department.

- B. Place New Concrete.** After all specified existing materials have been removed, place new Class "M" Concrete to the scarified grade and finish to receive the new overlay as shown on the detail drawings.

Blast clean and roughen all areas of existing concrete and structural steel to come in contact with new concrete until free of all laitance and deleterious substances immediately prior to the placement of the Class "M" Concrete. The surface areas of existing concrete to come in contact with the new Class "M" Concrete are to be coated with an epoxy bond coat immediately prior to placing new concrete in accordance with Section 511. The interfaces of the new and old concrete shall be as nearly vertical and horizontal as possible.

C. Additional Steel Reinforcement. Furnish steel reinforcing bars for this work, as directed by the attached detail drawings. Splice these bars to the existing reinforcement in the deck in the areas of removed concrete to tie the slabs together as shown on the attached detail drawings. Ensure that all exposed steel reinforcement is tied in accordance with Section 602.03.04 prior to pouring the new Class “M” concrete.

IV. MEASUREMENT

- A. Eliminate Transverse Joint.** The Department will measure the quantity in linear feet along the centerline of the joint.
- B. Steel Reinforcement.** See Section 602.

V. PAYMENT

- A. Eliminate Transverse Joint.** Payment at the contract unit price per linear foot is full compensation for removing and disposing of the specified existing materials, furnishing and installing the concrete, and all incidental items necessary to complete the work (except the overlay material) within the specified pay limits as specified by this note and as shown on the attached detail drawings.
- B. Steel Reinforcement.** See Section 602.

The Department will consider payment as full compensation for all work required by this note and the attached detail drawings.

SPECIAL NOTE FOR STRUCTURES WITH FIBER REINFORCED POLYMER WRAP

Bundle 19.03.09

Grant County 06-10010.00 041B00011N

I. DESCRIPTION

Perform all work in accordance with the Kentucky Transportation Cabinet, Department of Highways 2012 Standard Specifications for Road and Bridge Construction and applicable Supplemental Specifications, the Standard Drawings, this Special Note, and the Contract Documents. Section references are to the Standard Specifications.

This work consists of the following:

1. Furnish all labor, materials, tools, equipment, and incidental items necessary to complete the work.
2. Provide safe access to the bridge, in accordance with Section 107.01.01, for the Engineer to sound possible repair areas and for workers to complete the construction.
3. Repair cracks as applicable in accordance with the Special Note for Epoxy Injection Crack Repair.
4. Repair delaminated or spalled areas as applicable in accordance with the Special Note for Concrete Patching.
5. Design and install a carbon fiber reinforced polymer (CFRP) strengthening and protection system.
6. Any other work as specified as part of this contract.

II. MATERIALS

One manufacturer shall supply all materials required for the CFRP system. The manufacturer shall be one of three listed below or approved equal for the carbon fiber reinforced polymer (CFRP) strengthening and protection system.

Tyfo Fiberwrap System
Fyfe Company, LLC
4995 Murphy Canyon Road
Suite 110
San Diego, CA 92123

MasterBrace System
BASF Corporation
889 Valley Park Drive
Shakopee, MN 55379

QuakeWrap
6840 S Tucson Blvd
Tucson, AZ 85756

To be an approved equal CFRP material manufacturer, the manufacturer of the material shall have a history of at least 5 years for supplying the specified materials to highway or similar structural projects. The CFRP manufacturer must provide a history of a minimum of 15 installations completed in the last 2 years, durability testing, independent laboratory testing for corroded concrete repairs, design equivalence to the specified system, and all proposed material data.

CFRP materials shall have a current international code council evaluation service report (ICC ESR #) compliant with the 2018 IBC. Materials must provide structural and durability testing as defined in ICC AC125.

Polyester or other resins will not be allowed as a substitute to epoxy resins. Glass composite systems will not be allowed as a substitute to carbon composite systems.

III. CONSTRUCTION

- A. Design CFRP System.** The CFRP system shall be designed for the resistance(s) shown in the attached detail drawings and according to AASHTO FRPS-1 and ACI 440. Design calculations and details must be sealed by a Professional Engineer licensed in the State of Kentucky and must be submitted and approved by the Engineer prior to installation. Submittal information shall include:
- a. Manufacturer's product data sheets and material test data.
 - b. Installation and maintenance instructions.
 - c. Drawings detailing the type, locations, dimensions, number of layers, and orientations of all FRP materials to be installed.
 - d. Calculations to determine the layout of the FRP materials to be installed.
 - e. Quality control plan.
- B. Surface Preparation.** Concrete sealer is to be removed from the existing surfaces to the installer's satisfaction prior to the concrete cleaning and spall repair. Any deteriorated concrete is to be patched per the Special Note for Concrete Patching, then cleaned and prepared to the installer's satisfaction prior to the installation of the CFRP system. The repaired concrete surfaces shall be allowed to cure a minimum of 14 days. The surfaces shall be clean and free of fins, depressions, or other conditions that may affect the intended performance of the CFRP system. Corners perpendicular to the strong fiber direction shall be rounded to a minimum radius of 3/4". The certified and experienced installer responsible shall verify that all required surface preparation has been completed properly and that the CFRP system is cleared for installation.
- C. Composite Application.** The CFRP system shall only be installed by individuals certified in writing by the material supplier. To be an approved installer for the CFRP material, the installer must provide a history of a minimum of 15 installations completed in the last 2 years using the proposed CFRP material or an approved equal. The manufacturer shall be required to provide training to the crew that does the actual installation as well as construction oversight throughout the duration of the CFRP installations to ensure the materials are applied according to their design and specific material requirements. The manufacturer must submit the name of the installer's

company and provide certification the installer meets the quality and experience requirements to perform the work with the bid documents. References of these installations including descriptions and contact information will be reviewed by the Engineer. Installers without the proper certifications, experience, and references will not be allowed to complete this work.

Temperatures of the substrate to receive the composite, ambient temperatures, and the temperature of the CFRP materials shall be between 50°F and 95°F at the time of mixing of epoxy. The CFRP system shall be applied when the relative humidity is less than 85% and the substrate temperature is more than 5°F above the dew point. Applications of the CFRP shall begin within one hour of the mixing of epoxies.

The manufacturer shall designate the proper mixing procedure for the epoxy resins. Apply a primer coating of epoxy to surfaces of the substrate to receive the CFRP system. Saturate the carbon fiber in a documented successful manner that ensures full saturation of the carbon fiber prior to the installation of the CFRP. Saturation of the carbon fiber in place is not allowed. Apply the CFRP to the prepared and primed substrate using methods that proved a uniform tensile force over the width of the saturated carbon fabric. Strong fibers shall not deviate from the intended fiber direction more than 1/2" per 12" length of composite. Inspection of the installed composite shall be completed prior to the curing of the CFRP to ensure that all edges, seams, and other areas are properly adhered. During this inspection process, releasing of entrapped air and other identified deficiencies shall be addressed.

After the CFRP system has been installed, use thickened epoxy to detail all edges and seams to provide a smooth finish. Apply a final layer of thickened epoxy to the installed CFRP system for protection.

D. Coating System Application. After the epoxy sets, yet prior to the application of the urethane top coat, all defects (including bubbles, delaminations, and fabric tears) more than 1 square inch of the surface area, or as specified by the Engineer, shall be repaired as such:

- a. Small defects (on the order of 6" diameter) shall be injected or back filled with epoxy.
- b. Bubbles less than 12" in diameter shall be repaired by injecting the epoxy. Two holes shall be drilled into the bubble to allow injection of the epoxy and escape of the entrapped air.
- c. Bubbles, delaminations, and fabric tears greater than 12" in diameter shall be repaired by removing and reapplying the required number of layers of the composite and the required finish coatings. All repairs shall be approved by the Engineer.

The urethane top coat shall then be applied to the final epoxy coat, as determined by manufacturer.

E. Quality Control. Installer must follow the quality control manual for the installation of the CFRP Systems, produced by the manufacturer.

IV. MEASUREMENT

The Department will measure the quantity by square footage covered. The number of layers will not be counted.

V. PAYMENT

Payment at the contract unit price per square feet is full compensation for CFRP design, materials and installation, and all incidental items necessary to complete the work in accordance with this Special Note and as shown on the attached detail drawing(s).

<u><i>Code</i></u>	<u><i>Pay Item</i></u>	<u><i>Pay Unit</i></u>
25015EC	FRP Wrap	Square Feet

SPECIAL NOTE FOR ADDITIONAL ENVIRONMENTAL COMMITMENTS

Bundle 19.03.09

Grant County 06-10002.10 041B00013N

Grant County 06-10002.00 041B00014N

Grant County 06-10010.00 041B00011N

In addition to other environmental commitments listed in this contract, the following commitments also apply:

- 1) The Contractor shall not go beyond the limits specified as “archaeologically cleared” or “Archaeology APE,” and shall avoid areas identified as “Do Not Disturb.” If no limits are shown on the plans, the contractor shall adhere to the stipulations in the project-specific CAP. If there is no CAP, the contractor shall confine construction work to the previously disturbed area within the existing right of way. If the areas outside the cleared areas are intended for use as laydown yards, vehicle parking, or any other activity related to the construction of this project, the Contractor must clear the area for environmental concerns.
- 2) In the event that human remains are encountered during project activities, all work should be immediately stopped in the area. The area should be cordoned off, and, in accordance with KRS 72.020, the county coroner and local law enforcement must be contacted immediately. Upon confirmation that the human remains are not of forensic interest, the unanticipated discovery must be reported to Nicolas Laracuenta at the Kentucky Heritage Council at (502) 892-3614 and George Crothers at the Office of State Archaeology at (859) 257-1944.

For guidance regarding inadvertent discovery and treatment of human remains, refer to the KYTC’s Right of Way Guidance Manual (Section ROW-1202), and the Advisory Council on Historic Preservation’s (ACHP) Policy Statement Regarding Treatment of Human Remains and Grave Goods (adopted by ACHP February 23, 2007).

- 3) If, during the implementation of The Project, a previously unidentified historic/archaeological property is discovered or a previously identified historic/archaeological property is affected in an unanticipated manner, the contractor shall (1) call KYTC DEA archaeologists at (502) 564-7250, (2) call SHPO archaeologists at (502) 892-3614, and (3) ensure that all work within a reasonable area of the discovery shall cease until such time as a treatment plan can be developed and implemented.

Archaeologically Cleared Grant County SYP 06-10010.00



Project APE.

Archaeologically Cleared Grant County SYP 06-10002.10



Project APE.

Archaeologically Cleared Grant County SYP 06-10002.00

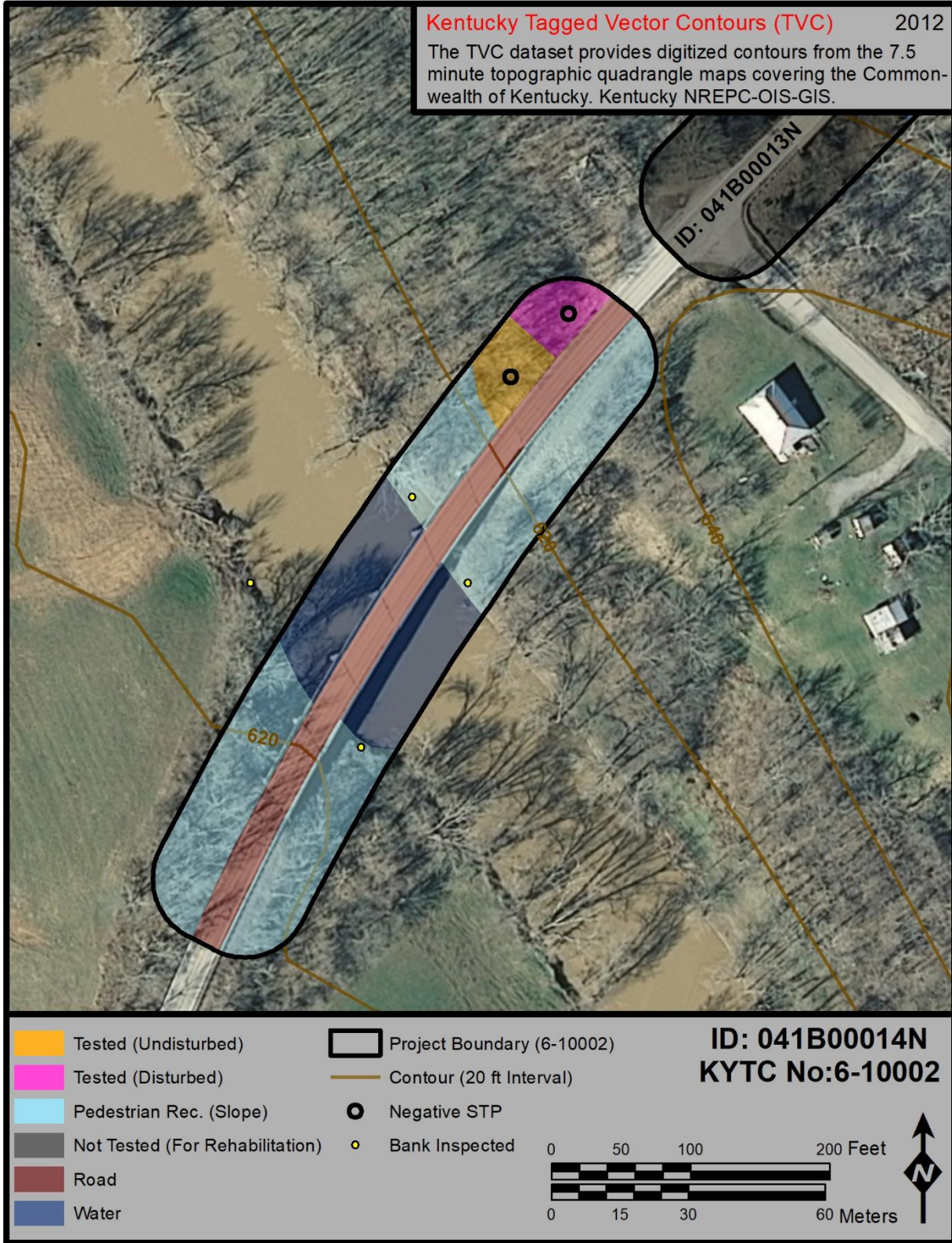

Figure 18. Bridge 041B00014N (Item No. 6-10002) showing project area conditions and excavated test locations on aerial map.

Special Note For Milestone Completions

Progress Milestone Completion

Progress Milestones are set up to ensure a continuous progression of work on the contract and state the number of bridges that must be completed by a specified date. Unless specified elsewhere in the contract, it is the Contractor's decision on which structures to complete by the milestone completion. Refer to Special Note for Liquidated Damages in this proposal. Failure to meet the required completion date for the number of structures will result in the Contractor being charged for Milestone Completion Damages equal to a percentage of the Liquidated Damages, as specified per section 108.09 of the Standard Specification applied at a rate equal to the formula below:

$$\left(\frac{\text{\# of Bridges failed to meet completion requirement}}{\text{Total \# of Bridges}} \right) \times \text{Liquidated Damage Daily Rate}$$

Bridge Specific Milestone Completion

Bridge Specific Milestones are set up for each structure and listed in the Special Note for Liquidated Damages as total days allowed for bridge closure or lane closure. In addition, certain structures may require completion by a specific date or some may not be allowed to be started until a specific date. In the event work is not complete by the specified date or within the specified range on more than one structure, Bridge Specific Milestone Completion Damages will be applied for each structure. Bridge Specific Milestone Completion Damages and the Liquidated Damage rates will be applied cumulatively.

For example, if two structures each allow for only 60 day bridge closures and both bridges are continuing to be worked on with the bridge closed at 61 days, then the Bridge Specific Milestone Completion Damages will be applied twice, once for each bridge. Also, should the Contractor violate both the specified number of days for a closure and the required completion date for that structure, Both Bridge Specific Milestone Completion Damages and Liquidated Damages will be applied cumulatively, for each violation.

MATERIAL SUMMARY

CONTRACT ID: 195067

041GR19D067-STP

BR04100221985

KY 22 ADDRESS DEFICIENCIES OF KY-22 BRIDGE OVER RATTLESNAKE CREEK (041B00013N) BRIDGE SUPERSTRUCTURE REHAB, A DISTANCE OF .04 MILES.

Project Line No	Bid Code	DESCRIPTION	Quantity	Unit
0005	02110	PARTIAL DEPTH PATCHING	53.00	CUFT
0010	02403	REMOVE CONCRETE MASONRY	7.30	CUYD
0015	02483	CHANNEL LINING CLASS II	40.00	TON
0020	02650	MAINTAIN & CONTROL TRAFFIC	1.00	LS
0025	02671	PORTABLE CHANGEABLE MESSAGE SIGN	2.00	EACH
0030	03299	ARMORED EDGE FOR CONCRETE	47.50	LF
0035	03300	ELIMINATE TRANSVERSE JOINT	47.50	LF
0040	03302	REPAIR CONCRETE CURB	20.00	LF
0045	03304	BRIDGE OVERLAY APPROACH PAVEMENT	132.00	SQYD
0050	08003	FOUNDATION PREPARATION	1.00	LS
0055	08100	CONCRETE-CLASS A	76.40	CUYD
0060	08104	CONCRETE-CLASS AA - (REVISED: 3-6-19)	62.00	CUYD
0065	08150	STEEL REINFORCEMENT	7,440.00	LB
0070	08151	STEEL REINFORCEMENT-EPOXY COATED - (REVISED: 3-6-19)	3,514.00	LB
0075	08504	EPOXY SAND SLURRY	75.40	SQYD
0080	08526	CONC CLASS M FULL DEPTH PATCH	4.00	CUYD
0085	08534	CONCRETE OVERLAY-LATEX	17.50	CUYD
0090	08549	BLAST CLEANING	420.00	SQYD
0095	08551	MACHINE PREP OF SLAB	420.00	SQYD
0100	21415ND	EROSION CONTROL	1.00	LS
0105	22146EN	CONCRETE PATCHING REPAIR	145.00	SQFT
0110	24982EC	CONCRETE COATING - Approx. 3400 SF	1.00	LS
0115	02569	DEMOBILIZATION	1.00	LS

MATERIAL SUMMARY

CONTRACT ID: 195067

041GR19D067-STP

BR04100221986

KY 22 ADDRESS DEFICIENCIES OF KY-22 BRIDGE OVER EAGLE CREEK (041B00014N) BRIDGE SUPERSTRUCTURE REHAB, A DISTANCE OF .06 MILES.

Project Line No	Bid Code	DESCRIPTION	Quantity	Unit
0005	02110	PARTIAL DEPTH PATCHING	109.00	CUFT
0010	02403	REMOVE CONCRETE MASONRY	7.30	CUYD
0015	02650	MAINTAIN & CONTROL TRAFFIC	1.00	LS
0020	02671	PORTABLE CHANGEABLE MESSAGE SIGN	2.00	EACH
0025	03299	ARMORED EDGE FOR CONCRETE	54.80	LF
0030	03300	ELIMINATE TRANSVERSE JOINT	137.20	LF
0035	03302	REPAIR CONCRETE CURB	30.00	LF
0040	03304	BRIDGE OVERLAY APPROACH PAVEMENT	132.00	SQYD
0045	08003	FOUNDATION PREPARATION	1.00	LS
0050	08100	CONCRETE-CLASS A	218.00	CUYD
0055	08104	CONCRETE-CLASS AA - (REVISED: 3-6-19)	118.10	CUYD
0060	08150	STEEL REINFORCEMENT	30,270.00	LB
0065	08151	STEEL REINFORCEMENT-EPOXY COATED - (REVISED: 3-6-19)	6,562.00	LB
0070	08504	EPOXY SAND SLURRY	150.80	SQYD
0075	08526	CONC CLASS M FULL DEPTH PATCH	8.10	CUYD
0080	08534	CONCRETE OVERLAY-LATEX	35.00	CUYD
0085	08549	BLAST CLEANING	839.20	SQYD
0090	08551	MACHINE PREP OF SLAB	839.20	SQYD
0095	21415ND	EROSION CONTROL	1.00	LS
0100	22146EN	CONCRETE PATCHING REPAIR	320.00	SQFT
0105	24116EC	DEBRIS CLEANING	1.00	LS
0110	24982EC	CONCRETE COATING - Approx 9800 SF	1.00	LS
0115	02569	DEMOBILIZATION	1.00	LS

MATERIAL SUMMARY

CONTRACT ID: 195067

041GR19D067-STP

BR04100221987

KY 22 ADDRESS DEFICIENCIES OF KY-22 BRIDGE OVER CLARKS CRK + BATON ROUGE R. (041B00011N), FROM MP 6.594 TO MP 6.64 BRIDGE REPAIRS, A DISTANCE OF .05 MILES.

Project Line No	Bid Code	DESCRIPTION	Quantity	Unit
0005	01890	ISLAND HEADER CURB TYPE 1	75.00	LF
0010	01982	DELINEATOR FOR GUARDRAIL MONO DIRECTIONAL WHITE	4.00	EACH
0015	02351	GUARDRAIL-STEEL W BEAM-S FACE	112.50	LF
0020	02360	GUARDRAIL TERMINAL SECTION NO 1	1.00	EACH
0025	02363	GUARDRAIL CONNECTOR TO BRIDGE END TY A	4.00	EACH
0030	02381	REMOVE GUARDRAIL	125.00	LF
0035	02391	GUARDRAIL END TREATMENT TYPE 4A	1.00	EACH
0040	02545	CLEARING AND GRUBBING - Less than 1 acre	1.00	LS
0045	02650	MAINTAIN & CONTROL TRAFFIC	1.00	LS
0050	02671	PORTABLE CHANGEABLE MESSAGE SIGN	2.00	EACH
0055	02731	REMOVE STRUCTURE	1.00	LS
0060	03299	ARMORED EDGE FOR CONCRETE	55.00	LF
0065	03300	ELIMINATE TRANSVERSE JOINT	110.00	LF
0070	03304	BRIDGE OVERLAY APPROACH PAVEMENT	228.00	SQYD
0075	08019	CYCLOPEAN STONE RIP RAP	865.00	TON
0080	08100	CONCRETE-CLASS A	167.00	CUYD
0085	08150	STEEL REINFORCEMENT	21,710.00	LB
0090	08151	STEEL REINFORCEMENT-EPOXY COATED	3,240.00	LB
0095	08504	EPOXY SAND SLURRY	212.00	SQYD
0100	08534	CONCRETE OVERLAY-LATEX	31.00	CUYD
0105	08549	BLAST CLEANING	948.00	SQYD
0110	08551	MACHINE PREP OF SLAB	729.00	SQYD
0115	21415ND	EROSION CONTROL	1.00	LS
0120	21532ED	RAIL SYSTEM TYPE III	480.00	LF
0125	22146EN	CONCRETE PATCHING REPAIR	808.00	SQFT
0130	24094EC	PARTIAL DEPTH PATCHING	2.00	CUYD
0135	24982EC	CONCRETE COATING - Approx. 15,257 Sf	1.00	LS
0140	25015EC	FRP WRAP	6,900.00	SQFT
0145	02569	DEMOBILIZATION	1.00	LS

PROPOSAL BID ITEMS

Report Date 3/6/19

Section: 0001 - BRIDGE - 041B00013N

LINE	BID CODE	ALT	DESCRIPTION	QUANTITY	UNIT	UNIT PRIC	FP	AMOUNT
0010	02110		PARTIAL DEPTH PATCHING	53.00	CUFT		\$	
0020	02403		REMOVE CONCRETE MASONRY	7.30	CUYD		\$	
0030	02483		CHANNEL LINING CLASS II	40.00	TON		\$	
0040	02650		MAINTAIN & CONTROL TRAFFIC	1.00	LS		\$	
0050	02671		PORTABLE CHANGEABLE MESSAGE SIGN	2.00	EACH		\$	
0060	03299		ARMORED EDGE FOR CONCRETE	47.50	LF		\$	
0070	03300		ELIMINATE TRANSVERSE JOINT	47.50	LF		\$	
0080	03302		REPAIR CONCRETE CURB	20.00	LF		\$	
0090	03304		BRIDGE OVERLAY APPROACH PAVEMENT	132.00	SQYD		\$	
0100	08003		FOUNDATION PREPARATION	1.00	LS		\$	
0110	08100		CONCRETE-CLASS A	76.40	CUYD		\$	
0120	08104		CONCRETE-CLASS AA (REVISED: 3-6-19)	62.00	CUYD		\$	
0130	08150		STEEL REINFORCEMENT	7,440.00	LB		\$	
0140	08151		STEEL REINFORCEMENT-EPOXY COATED (REVISED: 3-6-19)	3,514.00	LB		\$	
0150	08504		EPOXY SAND SLURRY	75.40	SQYD		\$	
0160	08526		CONC CLASS M FULL DEPTH PATCH	4.00	CUYD		\$	
0170	08534		CONCRETE OVERLAY-LATEX	17.50	CUYD		\$	
0180	08549		BLAST CLEANING	420.00	SQYD		\$	
0190	08551		MACHINE PREP OF SLAB	420.00	SQYD		\$	
0200	21415ND		EROSION CONTROL	1.00	LS		\$	
0210	22146EN		CONCRETE PATCHING REPAIR	145.00	SQFT		\$	
0220	24982EC		CONCRETE COATING Approx. 3400 SF	1.00	LS		\$	

Section: 0002 - BRIDGE - 041B00014N

LINE	BID CODE	ALT	DESCRIPTION	QUANTITY	UNIT	UNIT PRIC	FP	AMOUNT
0230	02110		PARTIAL DEPTH PATCHING	109.00	CUFT		\$	
0240	02403		REMOVE CONCRETE MASONRY	7.30	CUYD		\$	
0250	02650		MAINTAIN & CONTROL TRAFFIC	1.00	LS		\$	
0260	02671		PORTABLE CHANGEABLE MESSAGE SIGN	2.00	EACH		\$	
0270	03299		ARMORED EDGE FOR CONCRETE	54.80	LF		\$	
0280	03300		ELIMINATE TRANSVERSE JOINT	137.20	LF		\$	
0290	03302		REPAIR CONCRETE CURB	30.00	LF		\$	
0300	03304		BRIDGE OVERLAY APPROACH PAVEMENT	132.00	SQYD		\$	
0310	08003		FOUNDATION PREPARATION	1.00	LS		\$	
0320	08100		CONCRETE-CLASS A	218.00	CUYD		\$	
0330	08104		CONCRETE-CLASS AA (REVISED: 3-6-19)	118.10	CUYD		\$	
0340	08150		STEEL REINFORCEMENT	30,270.00	LB		\$	
0350	08151		STEEL REINFORCEMENT-EPOXY COATED (REVISED: 3-6-19)	6,562.00	LB		\$	
0360	08504		EPOXY SAND SLURRY	150.80	SQYD		\$	
0370	08526		CONC CLASS M FULL DEPTH PATCH	8.10	CUYD		\$	
0380	08534		CONCRETE OVERLAY-LATEX	35.00	CUYD		\$	

PROPOSAL BID ITEMS

Report Date 3/6/19

LINE	BID CODE	ALT	DESCRIPTION	QUANTITY	UNIT	UNIT PRIC	FP	AMOUNT
0390	08549		BLAST CLEANING	839.20	SQYD		\$	
0400	08551		MACHINE PREP OF SLAB	839.20	SQYD		\$	
0410	21415ND		EROSION CONTROL	1.00	LS		\$	
0420	22146EN		CONCRETE PATCHING REPAIR	320.00	SQFT		\$	
0430	24116EC		DEBRIS CLEANING	1.00	LS		\$	
0440	24982EC		CONCRETE COATING Approx 9800 SF	1.00	LS		\$	

Section: 0003 - BRIDGE - 041B00011N

LINE	BID CODE	ALT	DESCRIPTION	QUANTITY	UNIT	UNIT PRIC	FP	AMOUNT
0450	01890		ISLAND HEADER CURB TYPE 1	75.00	LF		\$	
0460	01982		DELINEATOR FOR GUARDRAIL MONO DIRECTIONAL WHITE	4.00	EACH		\$	
0470	02351		GUARDRAIL-STEEL W BEAM-S FACE	112.50	LF		\$	
0480	02360		GUARDRAIL TERMINAL SECTION NO 1	1.00	EACH		\$	
0490	02363		GUARDRAIL CONNECTOR TO BRIDGE END TY A	4.00	EACH		\$	
0500	02381		REMOVE GUARDRAIL	125.00	LF		\$	
0510	02391		GUARDRAIL END TREATMENT TYPE 4A	1.00	EACH		\$	
0520	02545		CLEARING AND GRUBBING Less than 1 acre	1.00	LS		\$	
0530	02650		MAINTAIN & CONTROL TRAFFIC	1.00	LS		\$	
0540	02671		PORTABLE CHANGEABLE MESSAGE SIGN	2.00	EACH		\$	
0550	02731		REMOVE STRUCTURE	1.00	LS		\$	
0560	03299		ARMORED EDGE FOR CONCRETE	55.00	LF		\$	
0570	03300		ELIMINATE TRANSVERSE JOINT	110.00	LF		\$	
0580	03304		BRIDGE OVERLAY APPROACH PAVEMENT	228.00	SQYD		\$	
0590	08019		CYCLOPEAN STONE RIP RAP	865.00	TON		\$	
0600	08100		CONCRETE-CLASS A	167.00	CUYD		\$	
0610	08150		STEEL REINFORCEMENT	21,710.00	LB		\$	
0620	08151		STEEL REINFORCEMENT-EPOXY COATED	3,240.00	LB		\$	
0630	08504		EPOXY SAND SLURRY	212.00	SQYD		\$	
0640	08534		CONCRETE OVERLAY-LATEX	31.00	CUYD		\$	
0650	08549		BLAST CLEANING	948.00	SQYD		\$	
0660	08551		MACHINE PREP OF SLAB	729.00	SQYD		\$	
0670	21415ND		EROSION CONTROL	1.00	LS		\$	
0680	21532ED		RAIL SYSTEM TYPE III	480.00	LF		\$	
0690	22146EN		CONCRETE PATCHING REPAIR	808.00	SQFT		\$	
0700	24094EC		PARTIAL DEPTH PATCHING	2.00	CUYD		\$	
0710	24982EC		CONCRETE COATING Approx. 15,257 Sf	1.00	LS		\$	
0720	25015EC		FRP WRAP	6,900.00	SQFT		\$	

Section: 0004 - DEMOBILIZATION &/OR MOBILIZATION

LINE	BID CODE	ALT	DESCRIPTION	QUANTITY	UNIT	UNIT PRIC	FP	AMOUNT
0730	02569		DEMOBILIZATION	1.00	LS		\$	

KENTUCKY TRANSPORTATION CABINET DEPARTMENT OF HIGHWAYS BRIDGE REHABILITATION PLANS

INDEX OF SHEETS

Sheet No.	Description
S1	TITLE & LOCATION MAP
S2	GENERAL NOTES
S3	LAYOUT
S4	TYPICAL SECTION
S5	ABUTMENTS
S6	PIERS
S7-S11	FRAMING PLAN
S12	MISC. DETAILS

SPECIAL NOTES

- Armored Edges
- Bridge Overlay Approach Pavement
- Bridge Restoration and Waterproofing with Concrete Overlays
- Concrete Coating
- Concrete Patching Repair
- Distributed Galvanic Anodes
- Eliminate Traverser Joints
- Erosion Prevention and Sediment Control
- Fiber Reinforced Polymer Wrap
- Liquidated Damages
- Traffic Control on Bridge Repair Contracts
- Utilities and Rail Certification

ACTIVE SEPIAS

- Sepia 015 Guardrail Connector to Bridge End Type A
- Sepia 024 Typical Guardrail Installations
- Sepia 027 Steel Beam Guardrail (W-Beam)
- Sepia 028 Steel Guardrail Posts
- Sepia 030 Guardrail End Treatment Type 4A
- Sepia 032 Belmectors for Guardrail
- Sepia 033 Guardrail System Transition

STANDARD DRAWINGS

- BHS-008-02 Rail System Type 3
- BJE-001-13 Neoprene Expansion Dams and Armored Edges
- RBR-005-22 Guardrail Components
- RBR-010-06 Guardrail Terminal Sections

SPECIFICATIONS

2012 Standard Specifications for Road and Bridge Construction.
AASHTO LRFD Bridge Construction Specifications with Current Interims.

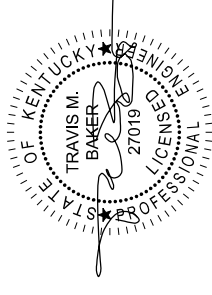

January 23, 2019

BRIDGE NUMBER

041B00011N

041B00011N
KY 22 OVER
CLARKS CREEK & BATON ROUGE ROAD
38.658850352, -84.672200736

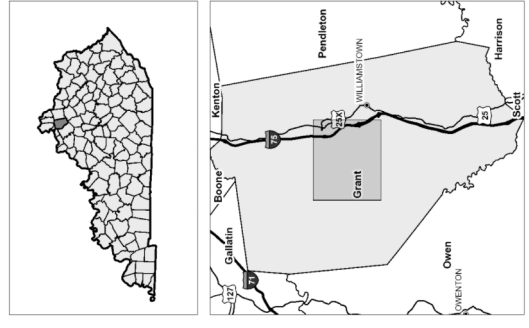
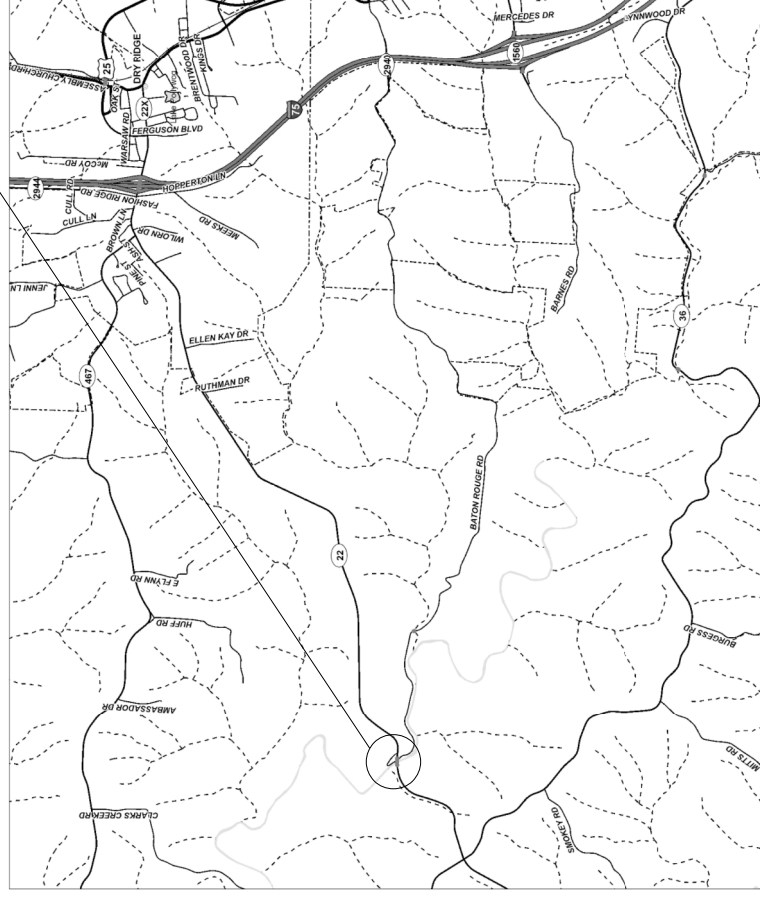

LOCATION MAP

ROUTE
KY 22

CLARKS CREEK & BATON ROUGE RD

TITLE & LOCATION MAP

PREPARED BY
AECOM

COUNTY
GRANT

CROSSING
CLARKS CREEK & BATON ROUGE RD

SHEET NO.
S1

DRAWING NO.
27895

KENTUCKY TRANSPORTATION CABINET DEPARTMENT OF HIGHWAYS BRIDGE REHABILITATION PLANS

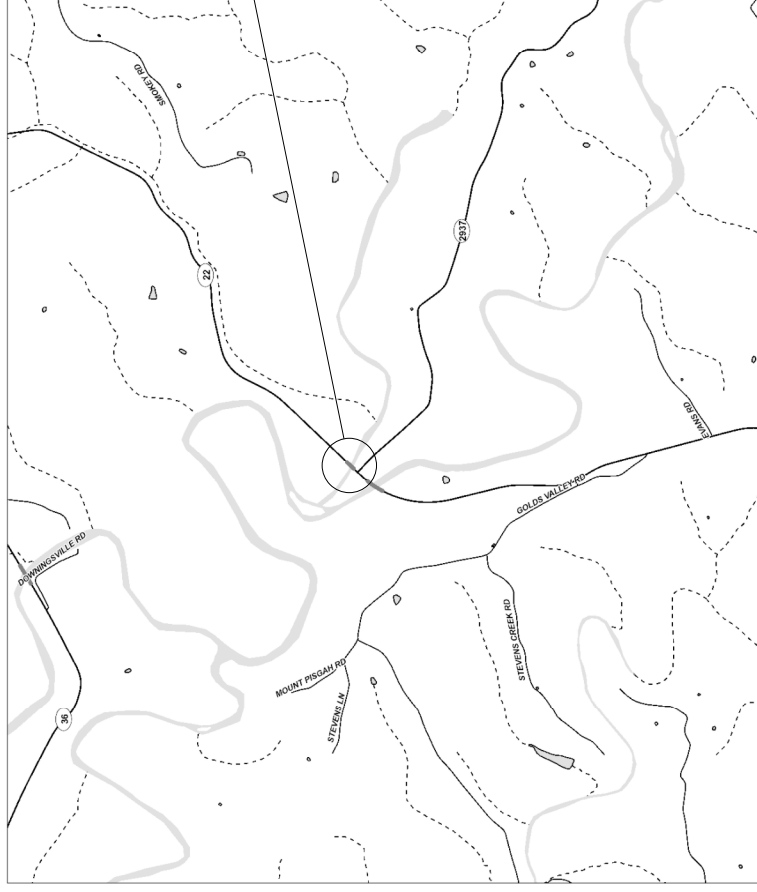
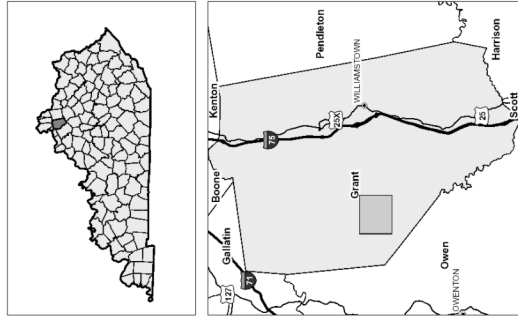

041B00013N
KY 22 Over
Rattlesnake Creek
38.629367, -84.708389

INDEX OF SHEETS

Sheet No.	Description
S1	Title & Location Map
S2	General Notes
S3	Plan & Elevation
S4	Typical Section
S5	Substructure
S6	Eliminate Transverse Joint
S7/S8	Maintenance of Traffic
S9	Temporary Rail System

SPECIAL NOTES

- For Traffic Control on Bridge Repair Contracts For Concrete Coating
- For Contract Completion Date and Liquidated Damages
- For Bridge Overlay Approach Pavement
- For Concrete Patching Repair
- For Erosion Prevention and Sediment Control For Concrete Overlays
- For Distributed Galvanic Anodes

ACTIVE SEPIAS

STANDARD DRAWINGS

- BJE-001-13 Neoprene Expansion Dams and Armored Edges
- BCX-006-10 Stencils for Structures
- RBR-001-12 Steel Beam Guardrail

SPECIFICATIONS

2012 Standard Specifications for Road and Bridge Construction.
AASHTO LRFD Bridge Construction Specifications with Current Interims.

Nasby R. Stroop

BRIDGE NUMBER	041B00013N
---------------	------------

DATE: 01/18/2019	CHECKED BY: D. CARPENTER	REVISION	DATE
DESIGNED BY: N. STROOP		DETAILED BY: C. BOR	
Commonwealth of Kentucky DEPARTMENT OF HIGHWAYS <small>COUNTY</small> GRANT			
ROUTE KY 22	CROSSING RATTLESNAKE CREEK	TITLE & LOCATION MAP	
<small>PREPARED BY</small> BRIDGING KENTUCKY		<small>SHEET NO.</small> S1	<small>DRAWING NO.</small> 27896

KENTUCKY TRANSPORTATION CABINET DEPARTMENT OF HIGHWAYS BRIDGE REHABILITATION PLANS

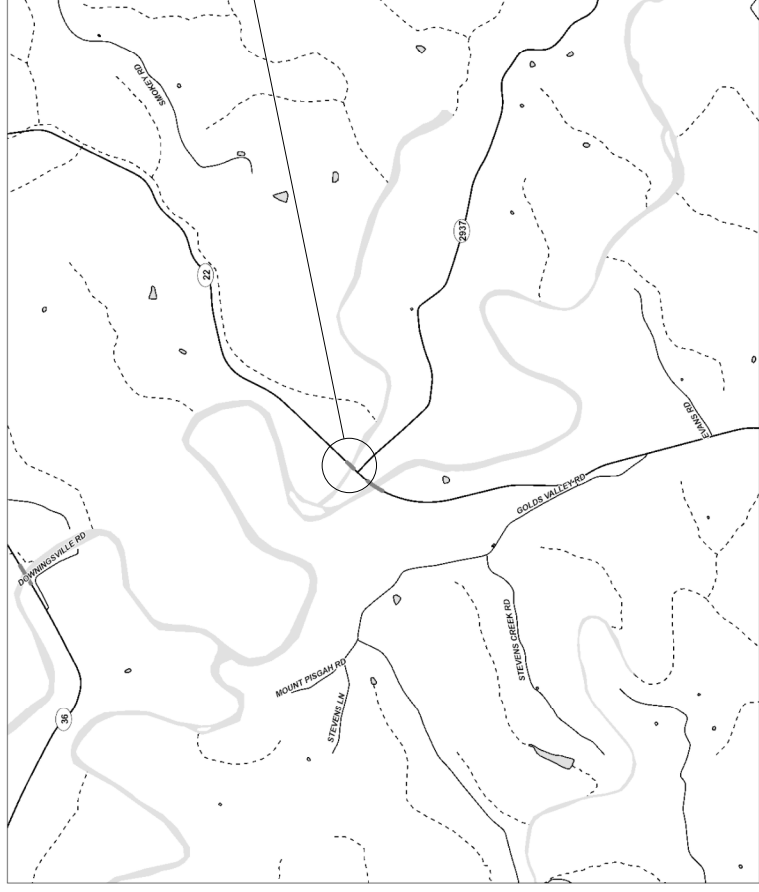
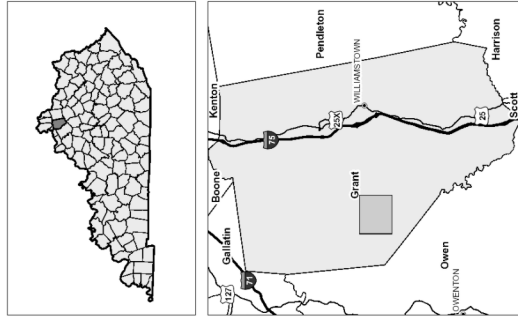

041B00013N
KY 22 Over
Rattlesnake Creek
38.629367, -84.708389

INDEX OF SHEETS

Sheet No.	Description
S1	Title & Location Map
S2	General Notes
S3	Plan & Elevation
S4	Typical Section
S5	Substructure
S6	Eliminate Transverse Joint
S7/S8	Maintenance of Traffic
S9	Temporary Rail System

SPECIAL NOTES

- For Traffic Control on Bridge Repair Contracts For Concrete Coating
- For Contract Completion Date and Liquidated Damages
- For Bridge Overlay Approach Pavement
- For Concrete Patching Repair
- For Erosion Prevention and Sediment Control For Concrete Overlays
- For Distributed Galvanic Anodes

ACTIVE SEPIAS

STANDARD DRAWINGS

- BJE-001-13 Neoprene Expansion Dams and Armored Edges
- BCX-006-10 Stencils for Structures
- RBR-001-12 Steel Beam Guardrail

SPECIFICATIONS

2012 Standard Specifications for Road and Bridge Construction.
AASHTO LRFD Bridge Construction Specifications with Current Interims.

Nasby R. Stroop

BRIDGE NUMBER
041B00013N

LOCATION MAP

DATE: 01/18/2019	CHECKED BY: D. CARPENTER	REVISION	DATE
DESIGNED BY: N. STROOP	DETAILED BY: C. BOR	N. STROOP	
Commonwealth of Kentucky DEPARTMENT OF HIGHWAYS <small>COUNTY</small> GRANT			
ROUTE KY 22	CROSSING RATTLESNAKE CREEK	TITLE & LOCATION MAP <small>PREPARED BY</small> 	
			<small>SHEET NO.</small> S1 <small>DRAWING NO.</small> 27896

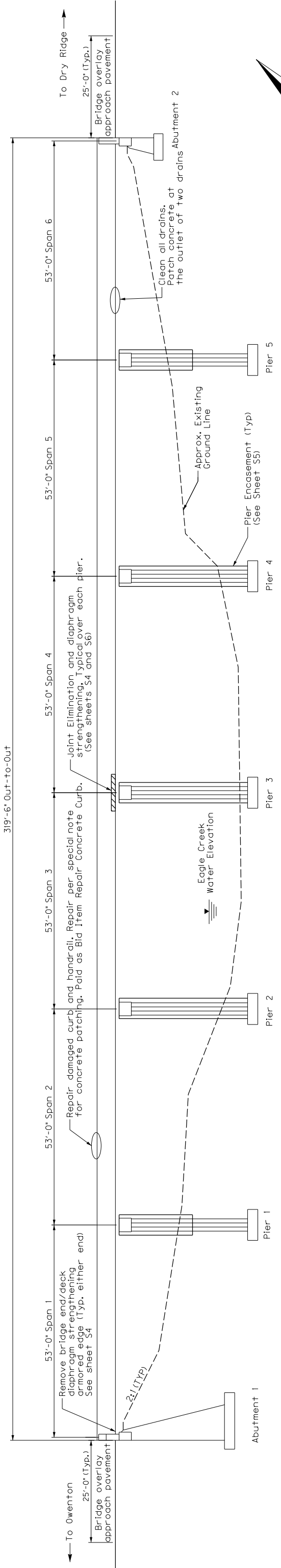

ELEVATION

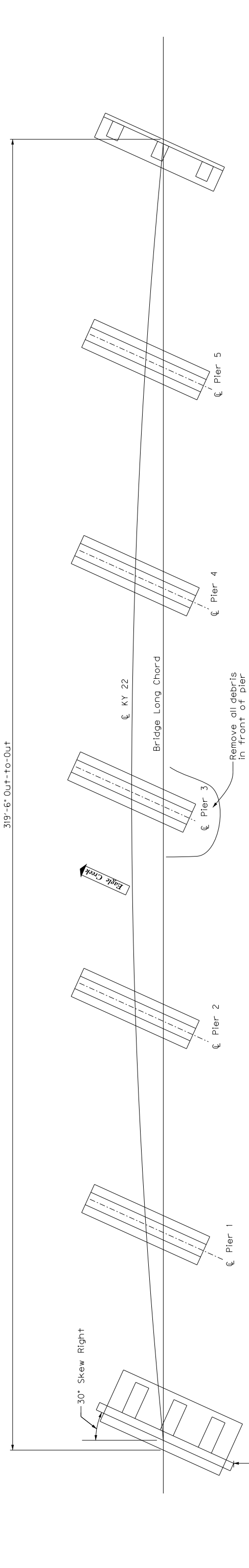

PLAN

- Notes:
- ① Curve Data: 3"-30' Curve Rt.
 - ② See Existing bridge drawing 5191
 - ③ Do not disturb existing quarndal
 - ④ Right of Way is 100'-0" either side of Centerline

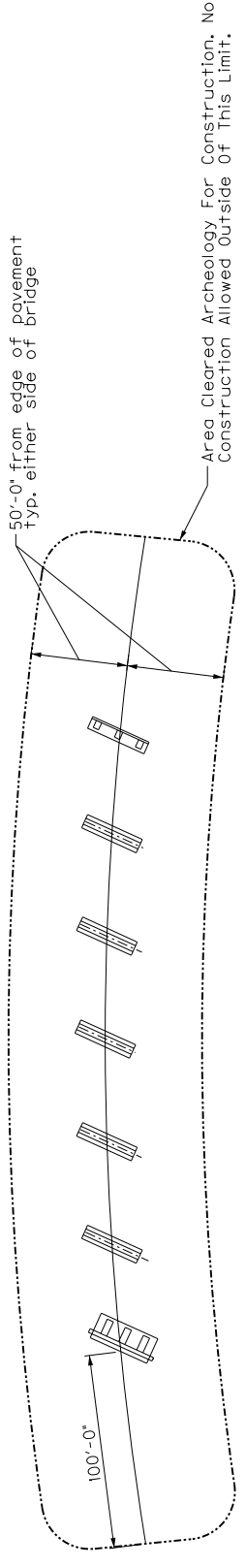

AREA CLEARED FOR CONSTRUCTION

DATE: 01/18/2019	CHECKED BY: D. CARPENTER
DESIGNED BY: N. STROOP	N. STROOP
DETAILED BY: C. BOR	
Commonwealth of Kentucky DEPARTMENT OF HIGHWAYS	
COUNTY GRANT	
ROUTE KY 22	CROSSING EAGLE CREEK
PLAN & ELEVATION	
PREPARED BY AEI	
BRIDGE NUMBER 041B00014N	
SHEET NO. S3	DRAWING NO. 27897

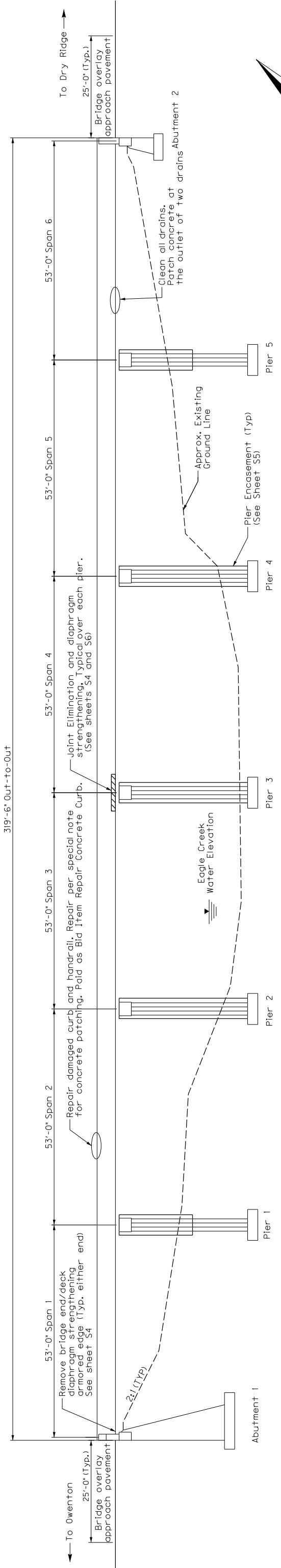

ELEVATION

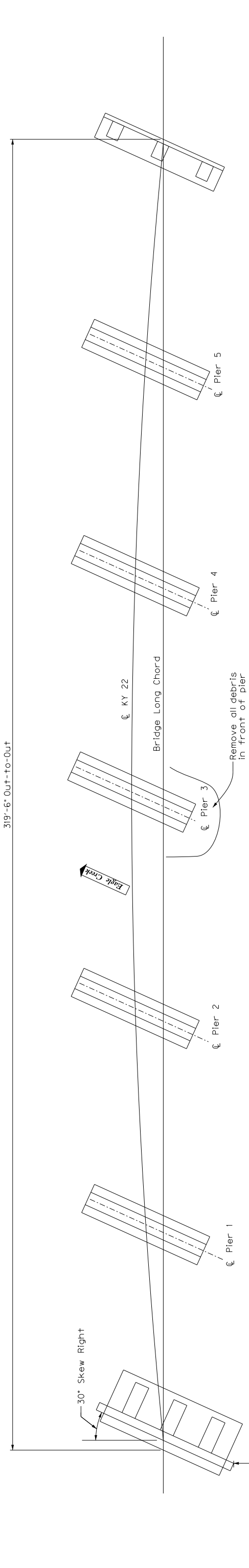

PLAN

- Notes:
- 1 Curve Data: 3"-30' Curve Rt.
 - 2 See Existing bridge drawing 5191
 - 3 Do not disturb existing quarndall
 - 4 Right of Way is 100'-0" either side of Centerline

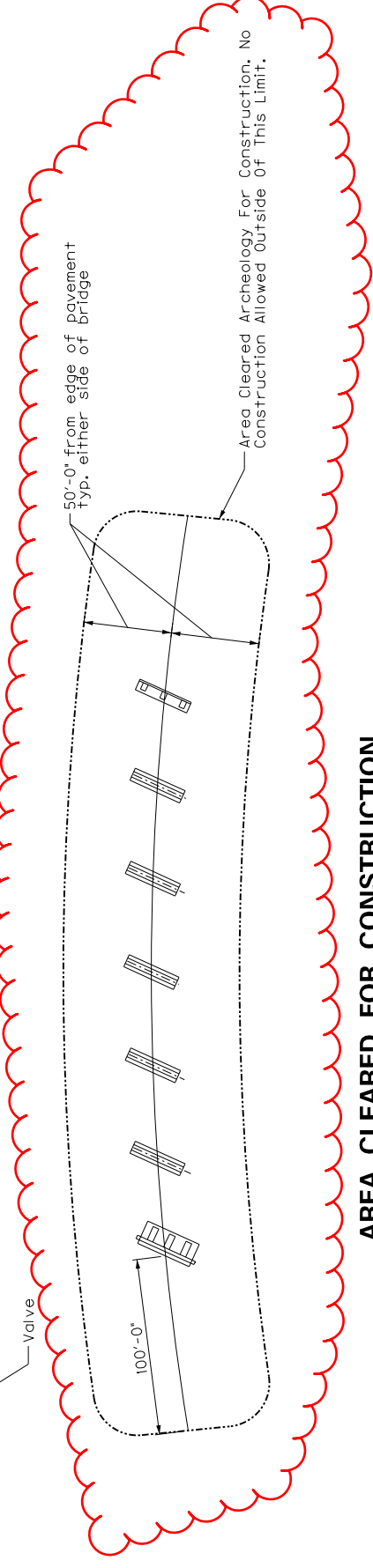

AREA CLEARED FOR CONSTRUCTION

REVISION	DATE
DESIGNED BY: N. STROOP	CHECKED BY: D. CARPENTER
DATE: 01/18/2019	DESIGNED BY: N. STROOP
DETAILED BY: C. BOR	DATE: 01/18/2019
Commonwealth of Kentucky DEPARTMENT OF HIGHWAYS	
COUNTY GRANT	
ROUTE KY 22	CROSSING EAGLE CREEK
PLAN & ELEVATION	
PREPARED BY AEI	SHEET NO. S3
BRIDGE NUMBER 041B00014N	DRAWING NO. 27897

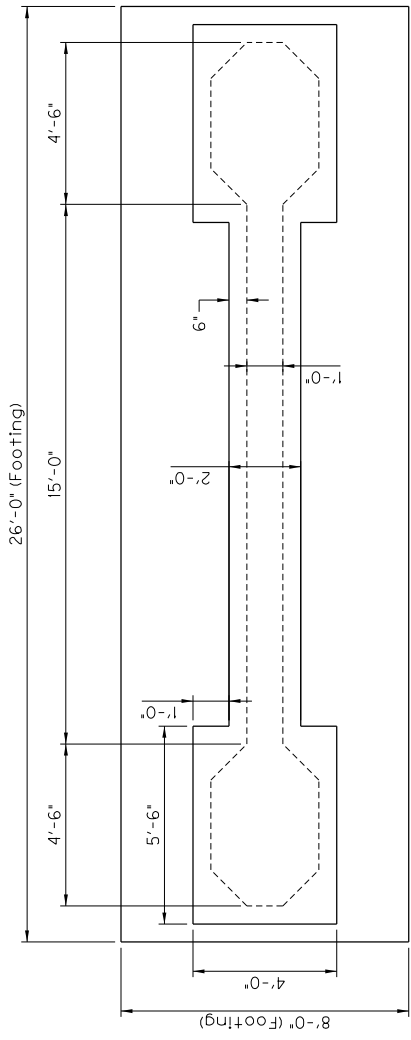

PLAN
COLUMN AND WEBWALL ENCASUREMENT

FILE NAME: ... \d016172\55 - Substructure.dgn

USER: jburT
DATE PLOTTED: 2/25/2019 12:33 PM

E-SHEET NAME:

ELEVATION

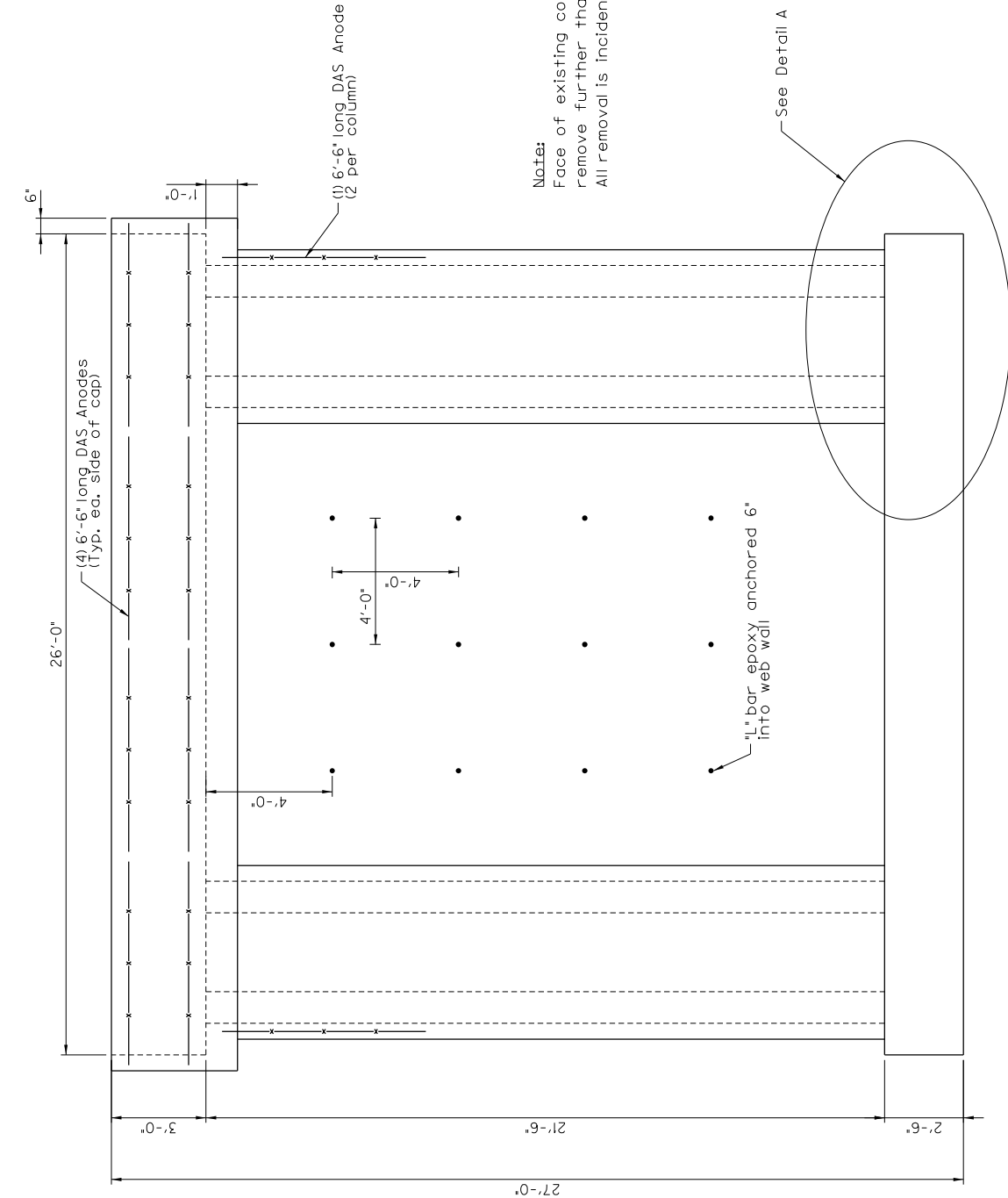

Note:
Face of existing concrete: Chip all loose, but do not remove further than the existing reinforcement.
All removal is incidental to Class A Concrete.

Notes:

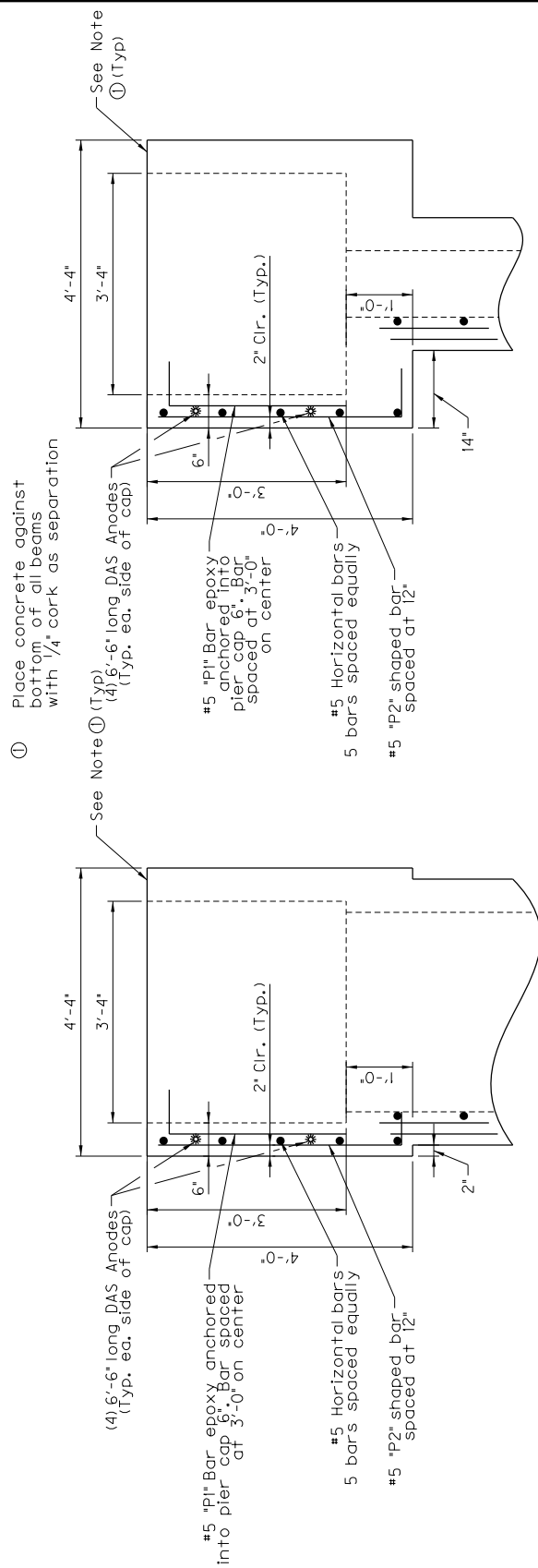

PIER CAP ENCASUREMENT AT COLUMN

PIER CAP ENCASUREMENT AT WEB WALL

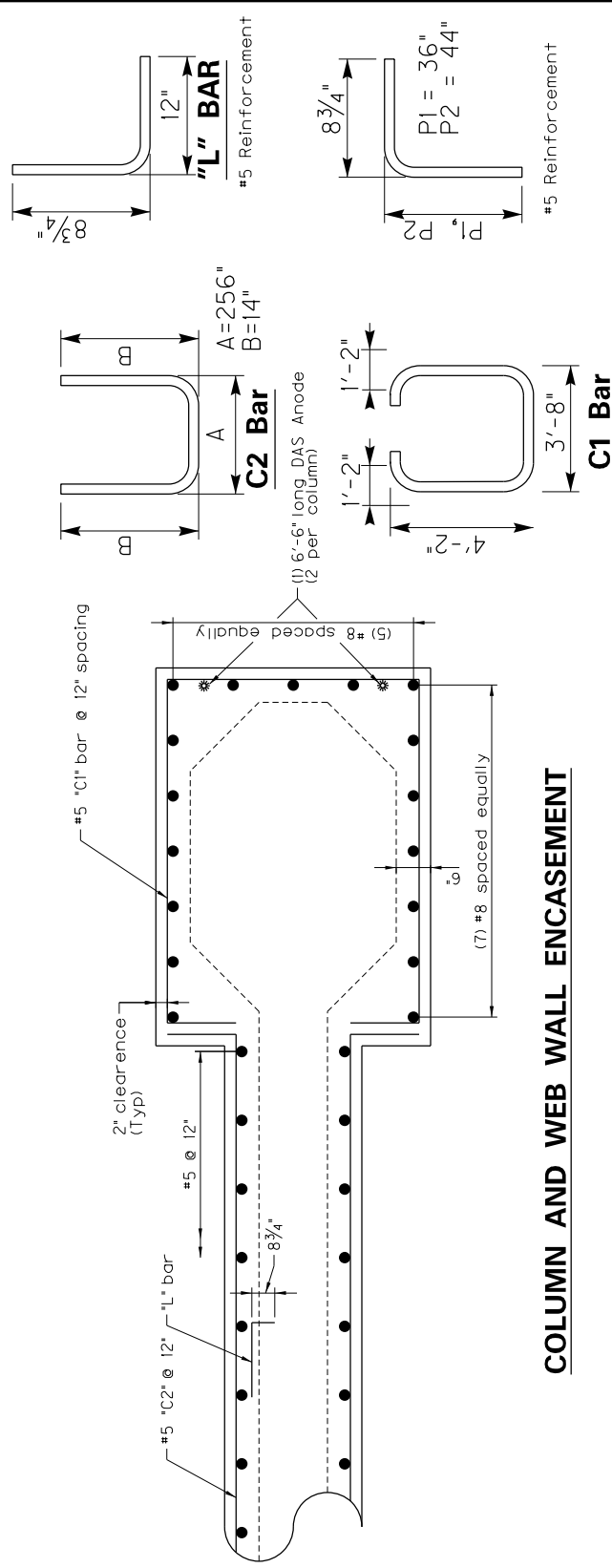

COLUMN AND WEB WALL ENCASUREMENT

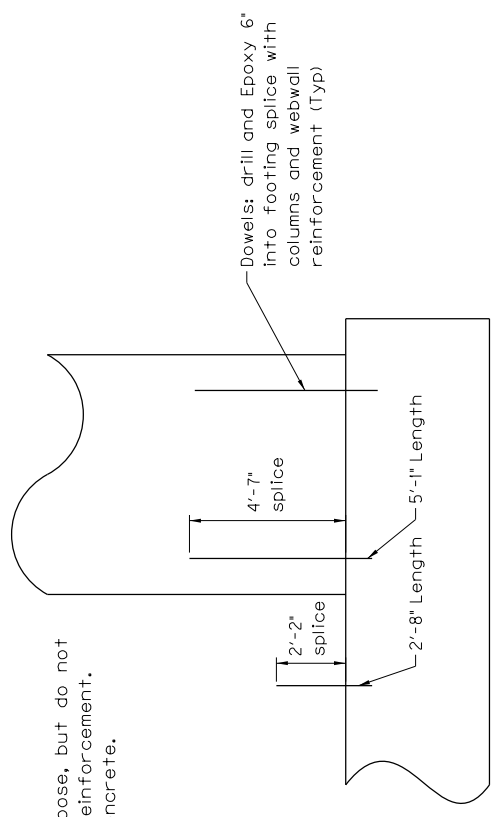

DETAIL A

See Detail A

ROUTE KY 22	GRANT	CROSSING RATTLESNAKE CREEK
SUBSTRUCTURE - PIERS		
PREPARED BY AEI		
BRIDGE NUMBER 041B00013N		

REVISION	DATE
DESIGNED BY: N. STROOP	CHECKED BY
DATE: 01/18/2019	D. CARPENTER
DETAILED BY: C. BOR	N. STROOP
Commonwealth of Kentucky DEPARTMENT OF HIGHWAYS	
COUNTY GRANT	

SHEET NO.
55
DRAWING NO.
27896

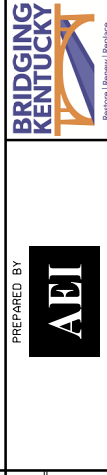

MicroStation V8.11.7.443

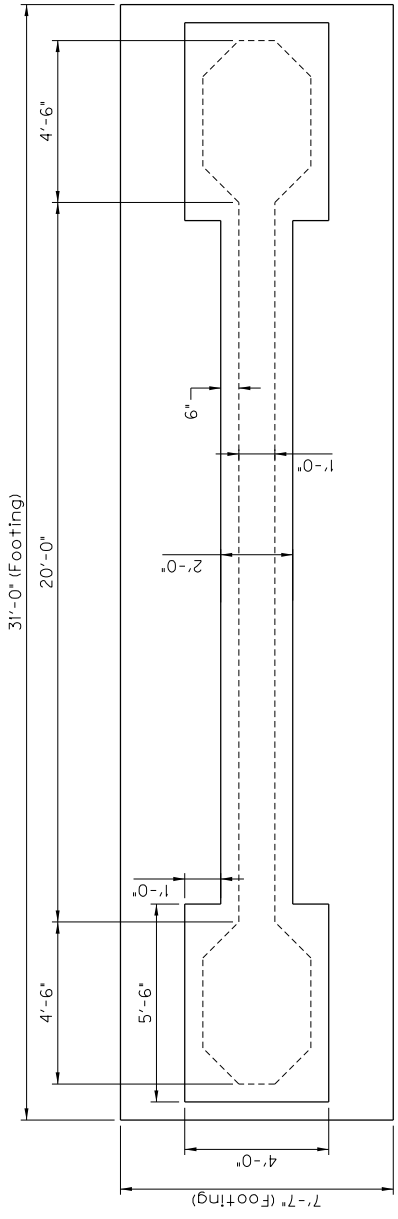

PLAN
COLUMN AND WEBWALL ENCASUREMENT

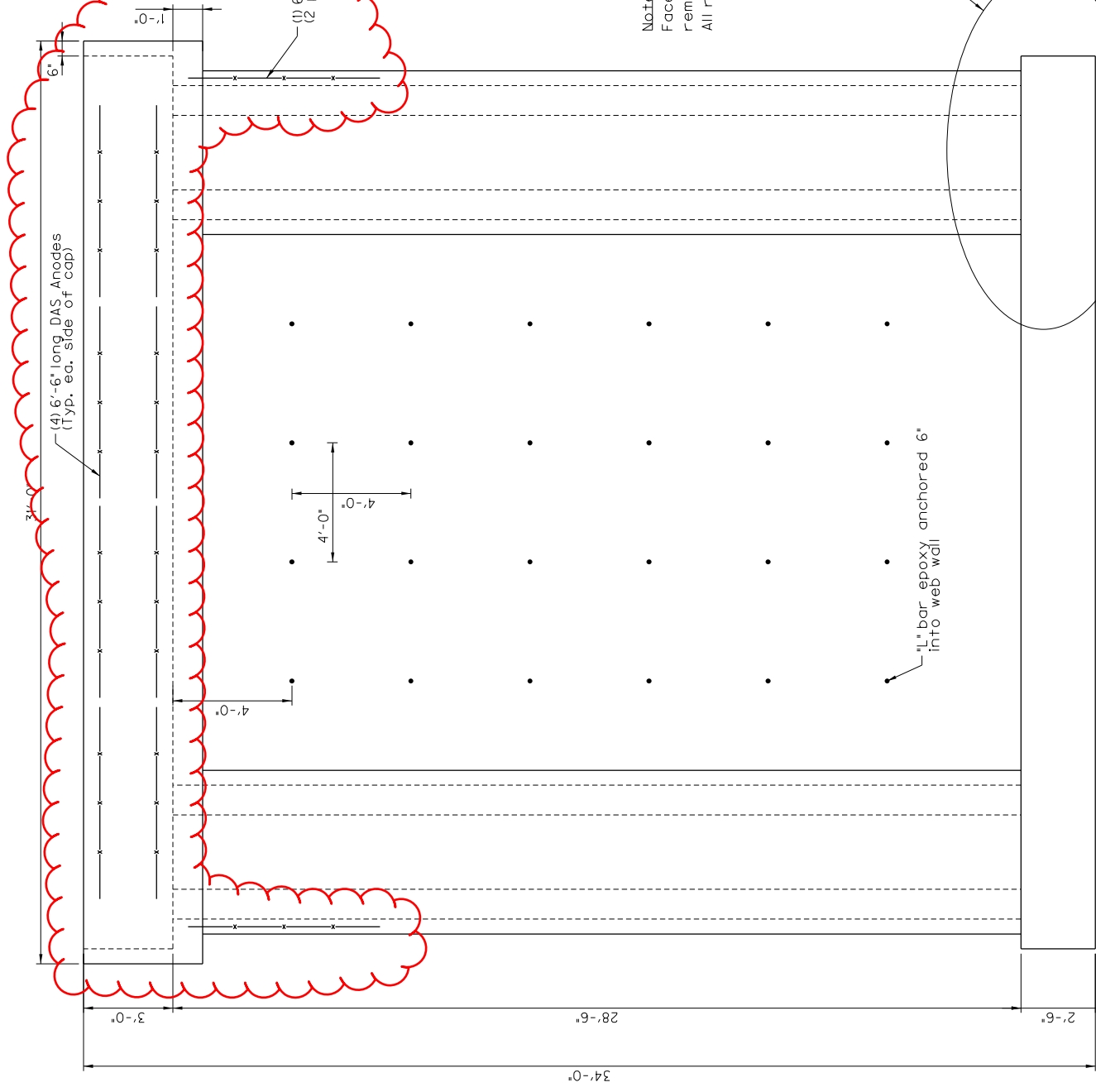

ELEVATION

Notes:

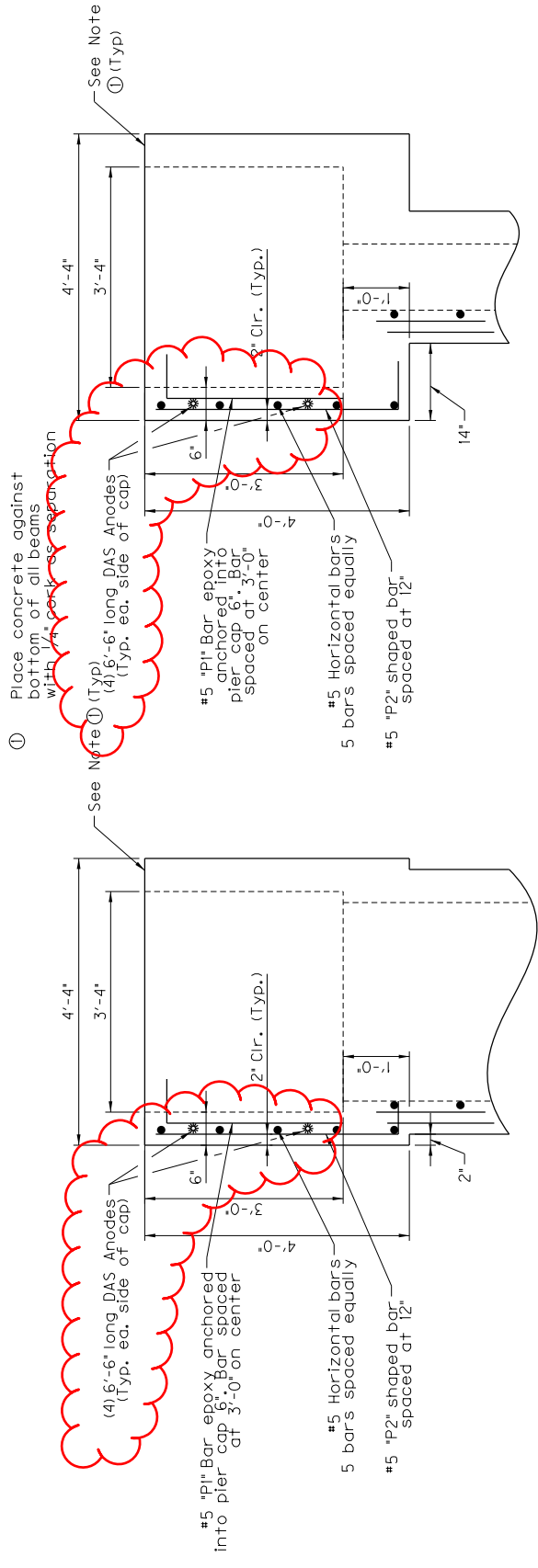

PIER CAP ENCASUREMENT AT COLUMN

PIER CAP ENCASUREMENT AT WEB WALL

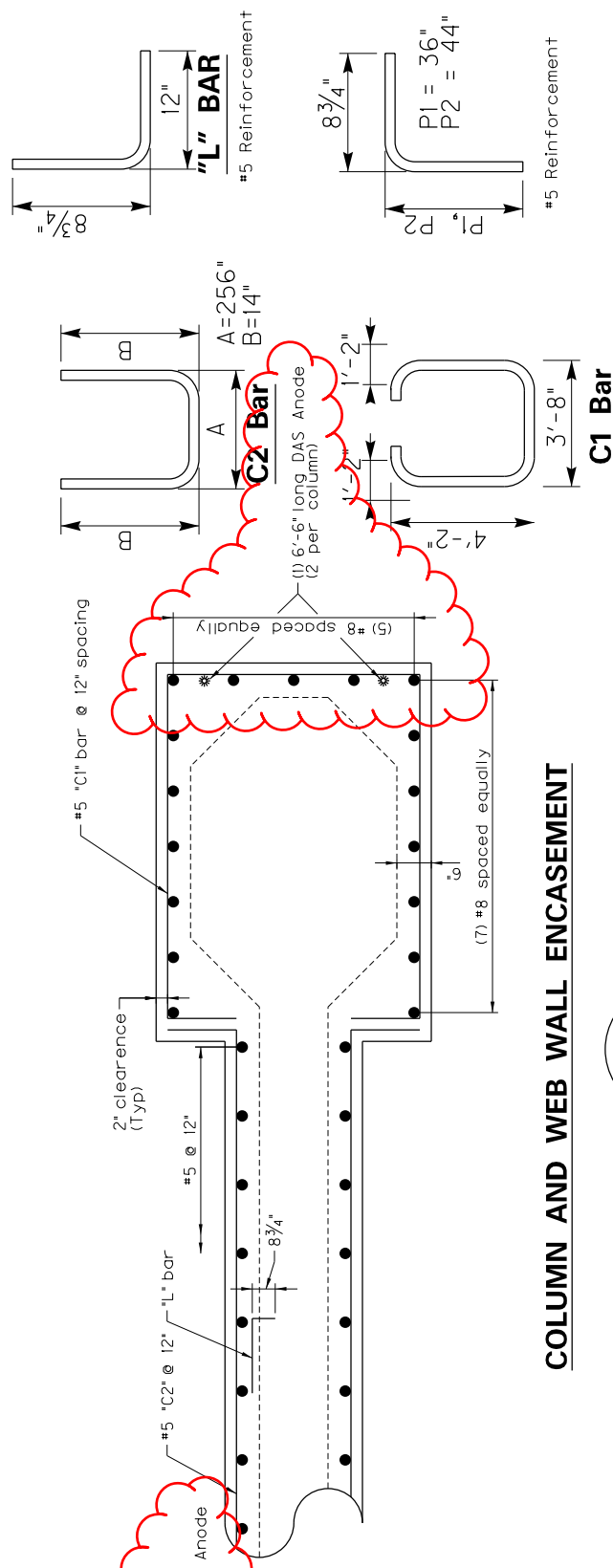

COLUMN AND WEB WALL ENCASUREMENT

Note:
Face of existing concrete: Chip all loose, but do not remove further than the existing reinforcement. All removal is incidental to Class A Concrete.

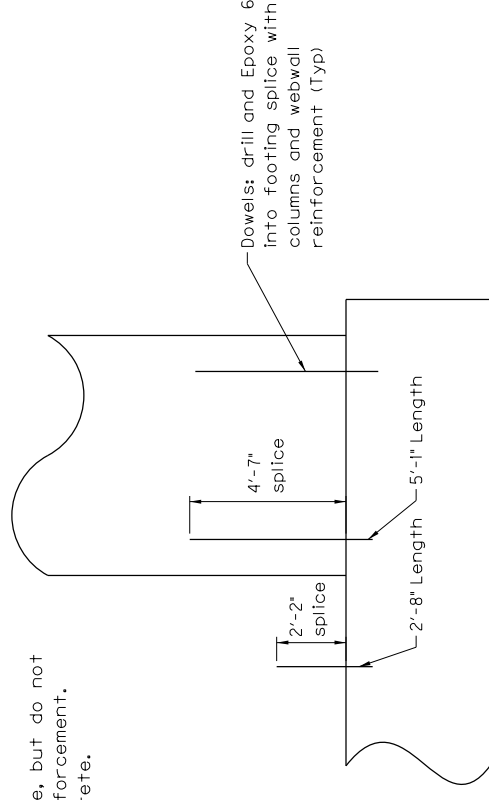

DETAIL A

See Detail A (This applies to Pier 2, 3 and 4 only)

Note:
Pier 2, 3 and 4 - Encase Piers from top of cap to top of footing.
Pier 1 and 5 - Encase Piers from top of cap to 15 ft. of column (18 ft. total)

REVISION	DATE
DESIGNED BY: N. STROOP	CHECKED BY: D. CARPENTER
DATE: 01/18/2019	DETAILED BY: C. BOR
N. STROOP	
Commonwealth of Kentucky DEPARTMENT OF HIGHWAYS COUNTY: GRANT	
ROUTE: KY 22	CROSSING: EAGLE CREEK
SUBSTRUCTURE - PIERS	
BRIDGE NUMBER: 041B00014N	PREPARED BY: AEI
SHEET NO. 55	DRAWING NO. 27897

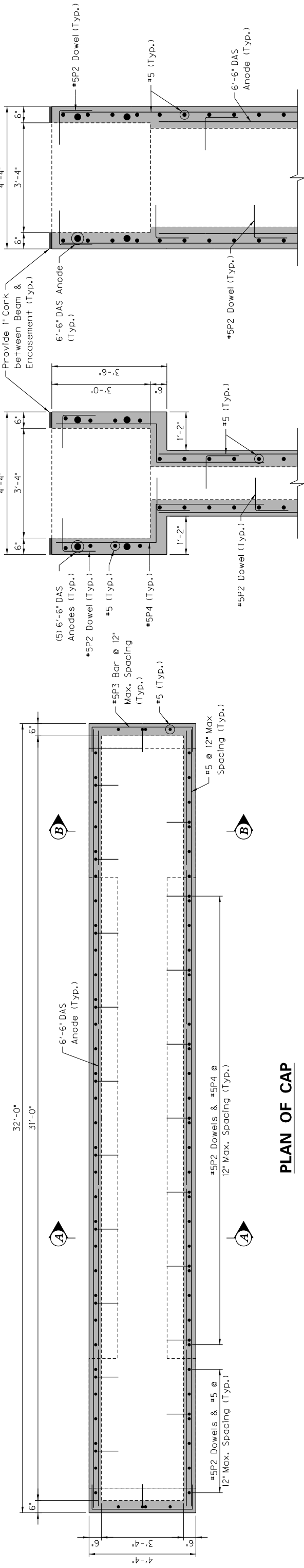

PLAN OF CAP

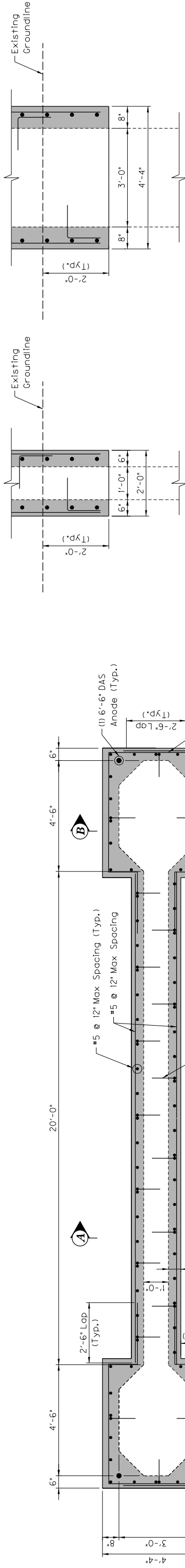

PLAN OF WALL & COLUMNS

Legend: New Class "A" Concrete Encasement

NOTES:

- In accordance with the Special Note for Concrete Patching Repair, remove any loose concrete prior to constructing pier encasement. Also see this note for treatment of existing reinforcing steel. All new concrete shall be Class A. Except for new steel reinforcement which will be measured and paid per Section 602, cost of all work, including all materials, labor, equipment, tools, and incidentals necessary, shall be incidental to Concrete - Class A.
- Proposed dimensions shown are approximate, adjust as needed to maintain 6' nominal thickness of encasement.

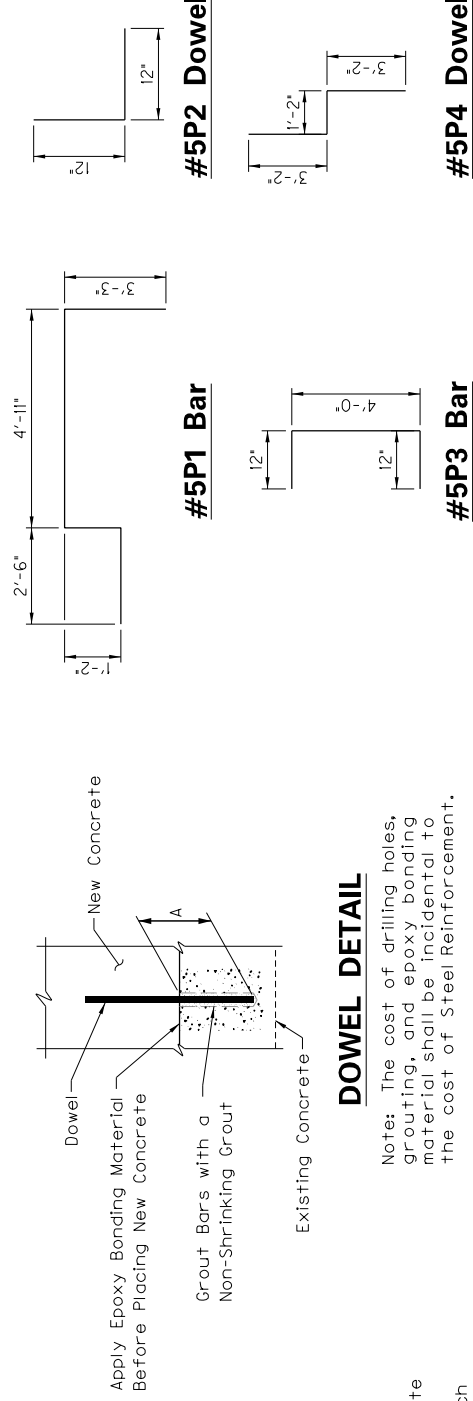

DOWEL DETAIL

Note: The cost of drilling holes, grouting, and epoxy bonding material shall be incidental to the cost of Steel Reinforcement.

Dowel	Dim. "A"
#5	8"

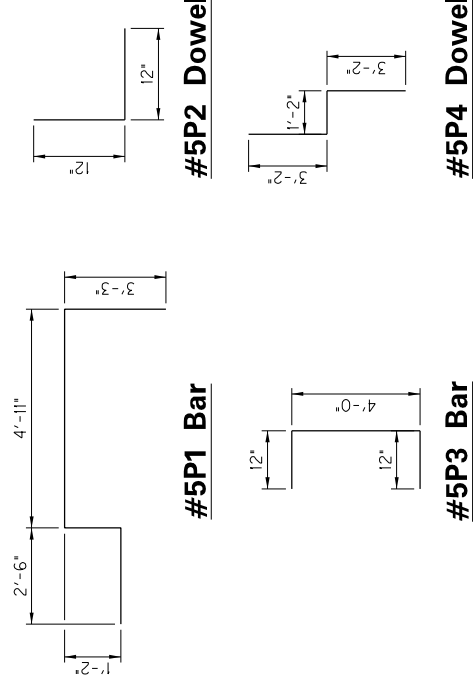

#5P2 Dowel

#5P1 Bar

#5P4 Dowel

#5P3 Bar

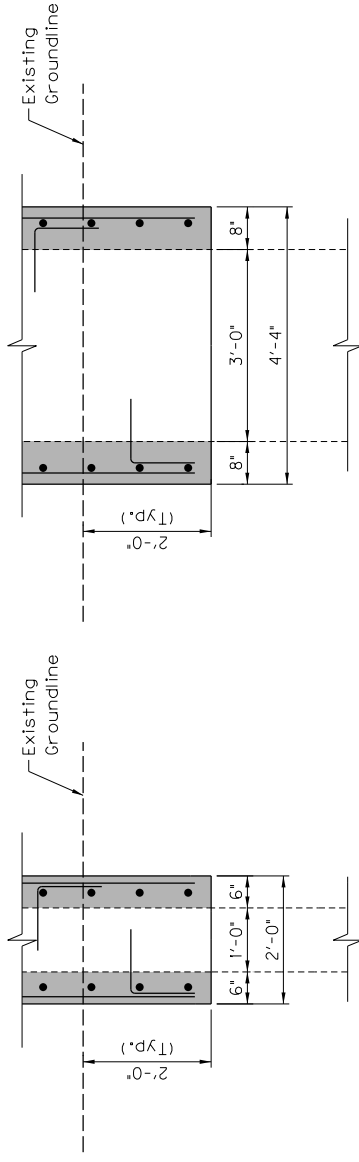

SECTION A-A

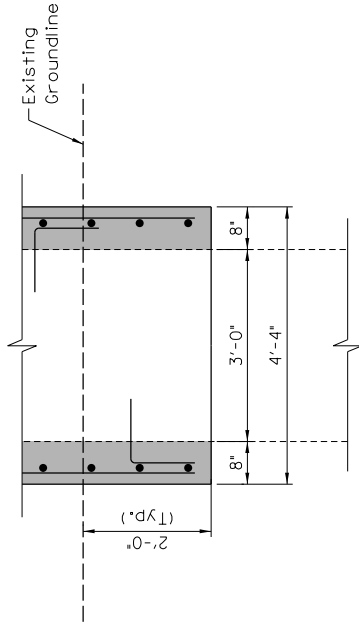

SECTION B-B

REVISION	DATE
DESIGNED BY: A. Foley	CHECKED BY: T. Baker
DATE: 1/18/2019	DETAILED BY: K. Meichtry
Commonwealth of Kentucky DEPARTMENT OF HIGHWAYS COUNTY: GRANT CROSSING: CLARKS CREEK & BATON ROUGE RD ROUTE: KY 22 PIERS	
AECOM PREPARED BY: BRIDGING KENTUCKY SHEET NO. 27895 DRAWING NO. 041B00011N	

BRIDGE NUMBER

041B00011N

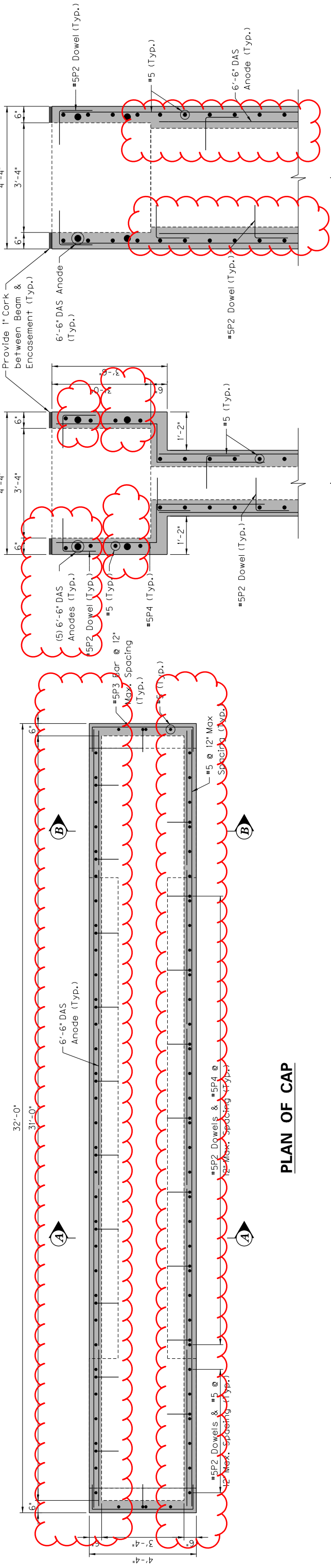

PLAN OF CAP

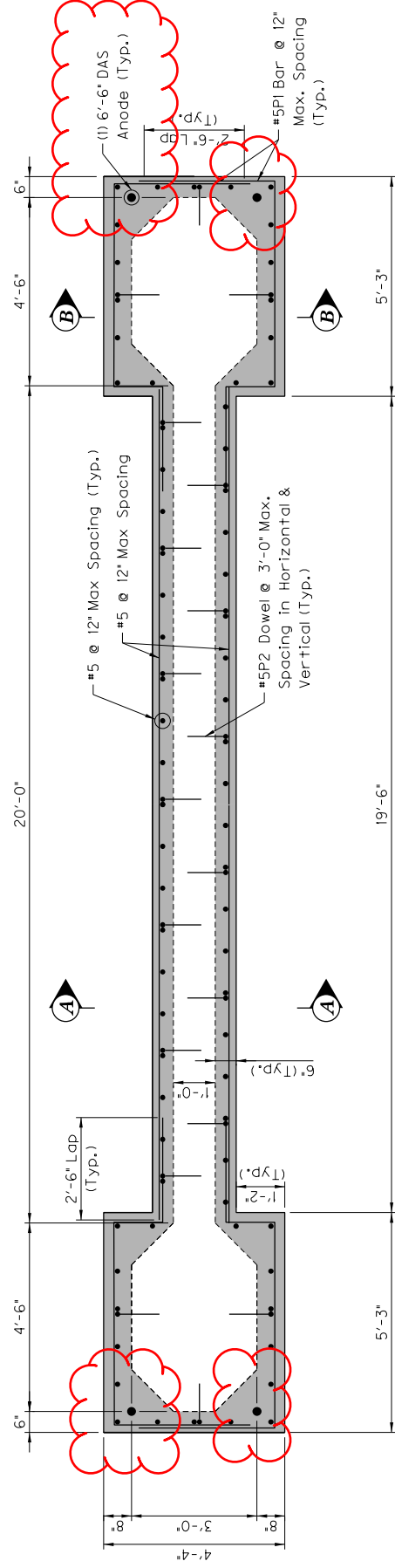

PLAN OF WALL & COLUMNS

Legend: New Class "A" Concrete Encasement

NOTES:

- In accordance with the Special Note for Concrete Patching Repair, remove any loose concrete prior to constructing pier encasement. Also see this note for treatment of existing reinforcing steel. All new concrete shall be Class A. Except for new steel reinforcement which will be measured and paid per Section 602, cost of all work, including all materials, labor, equipment, tools, and incidentals necessary, shall be incidental to Concrete - Class A.
- Proposed dimensions shown are approximate, adjust as needed to maintain 6' nominal thickness of encasement.

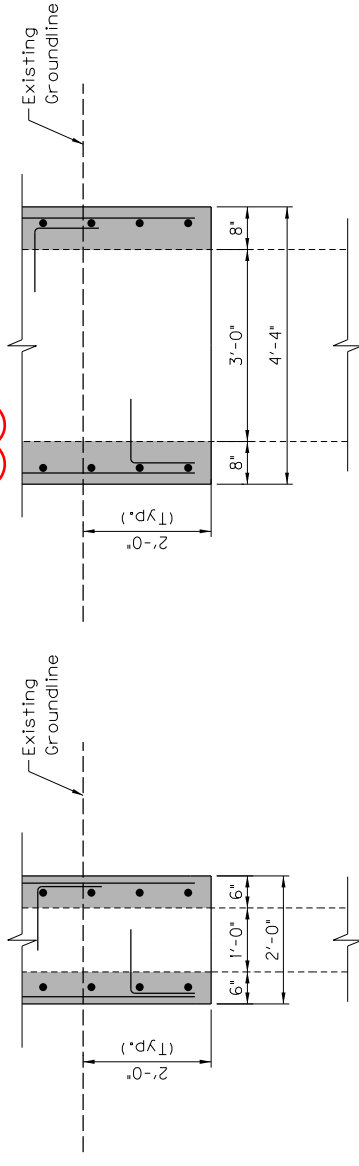

SECTION A-A

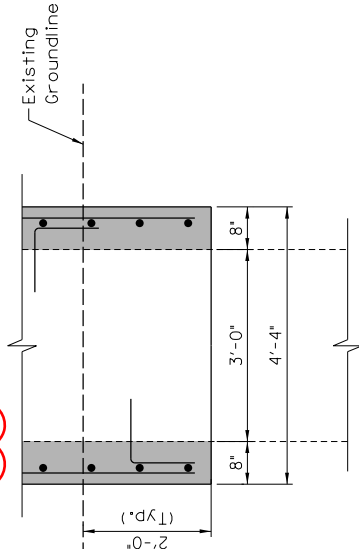

SECTION B-B

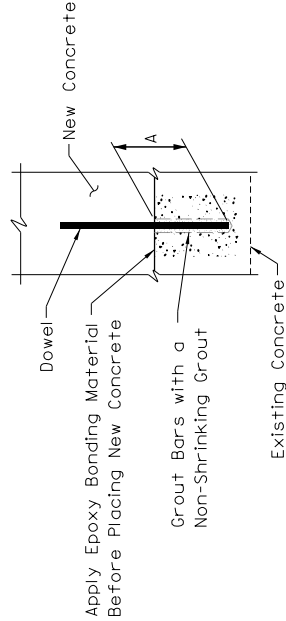
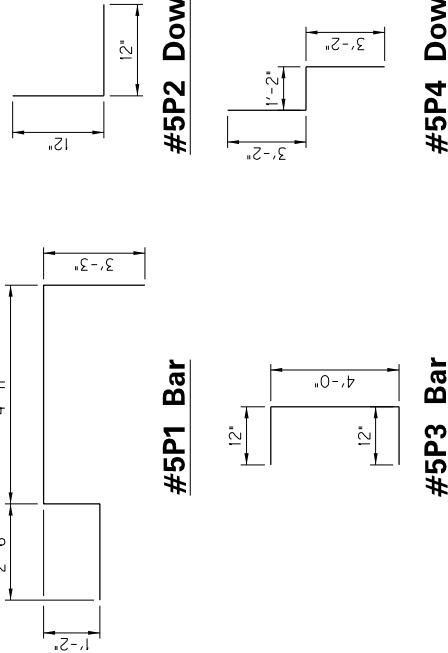

DOWEL DETAIL

Note: The cost of drilling holes, grouting, and epoxy bonding material shall be incidental to the cost of Steel Reinforcement.

Dowel	Dim. "A"
#5	8"

REVISION	DATE
DESIGNED BY: A. Foley	CHECKED BY: T. Baker
DATE: 1/18/2019	DETAILED BY: K. Meichtry
Commonwealth of Kentucky	
DEPARTMENT OF HIGHWAYS	
COUNTY GRANT	
ROUTE KY 22	CROSSING CLARKS CREEK & BATON ROUGE RD
PIERS	
AECOM	
BRIDGE NUMBER 041B00011N	
PREPARED BY	
SHEET NO. 27895	
DRAWING NO. 56	
BRIDGING KENTUCKY	

- Notes:
1. Bid Item 3300 "Eliminate Transverse Joint" includes all work and materials to remove the existing joint and replace the deck in the removal area unless otherwise noted.
 2. Class M concrete shall be used to replace the deck and curb in the removal area. Place concrete to match the existing slab/curb dimensions.
 3. All new reinforcement needed for "Eliminating Transverse Joint" shall be epoxy coated and included in the unit price bid for "Eliminate Transverse Joint".
 4. Minimal existing reinforcement is shown for clarity.
 5. Do not disturb rail with the exception of removing 6" of curb and realigning across the joint elimination area.
 6. DAS Anodes to be paid separate from the bid item 3300.

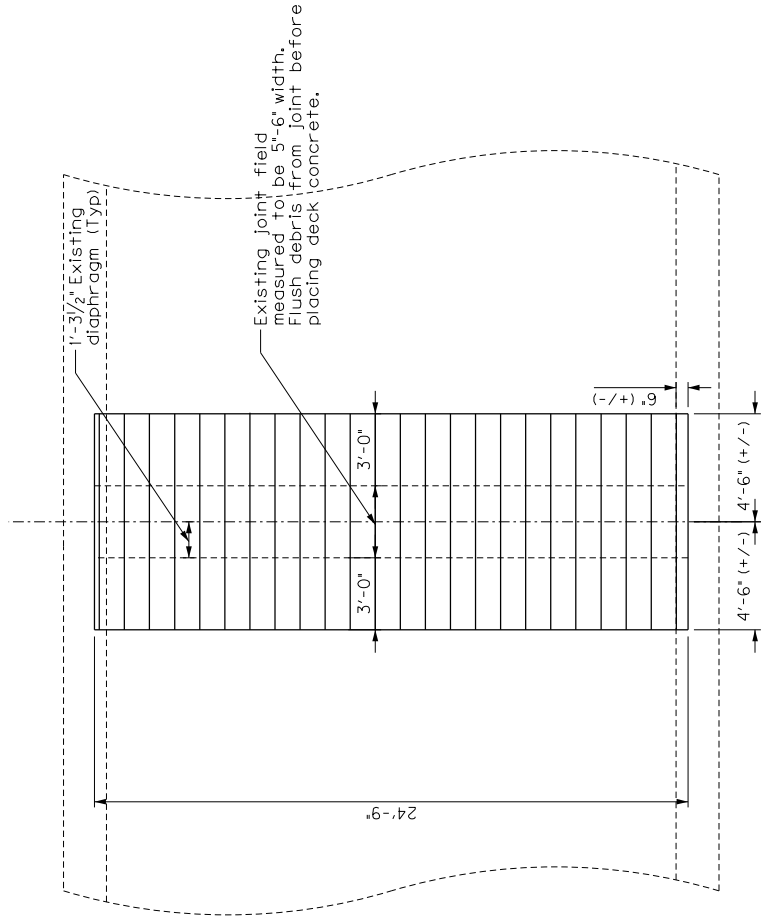

ELIMINATE TRANSVERSE JOINT PLAN

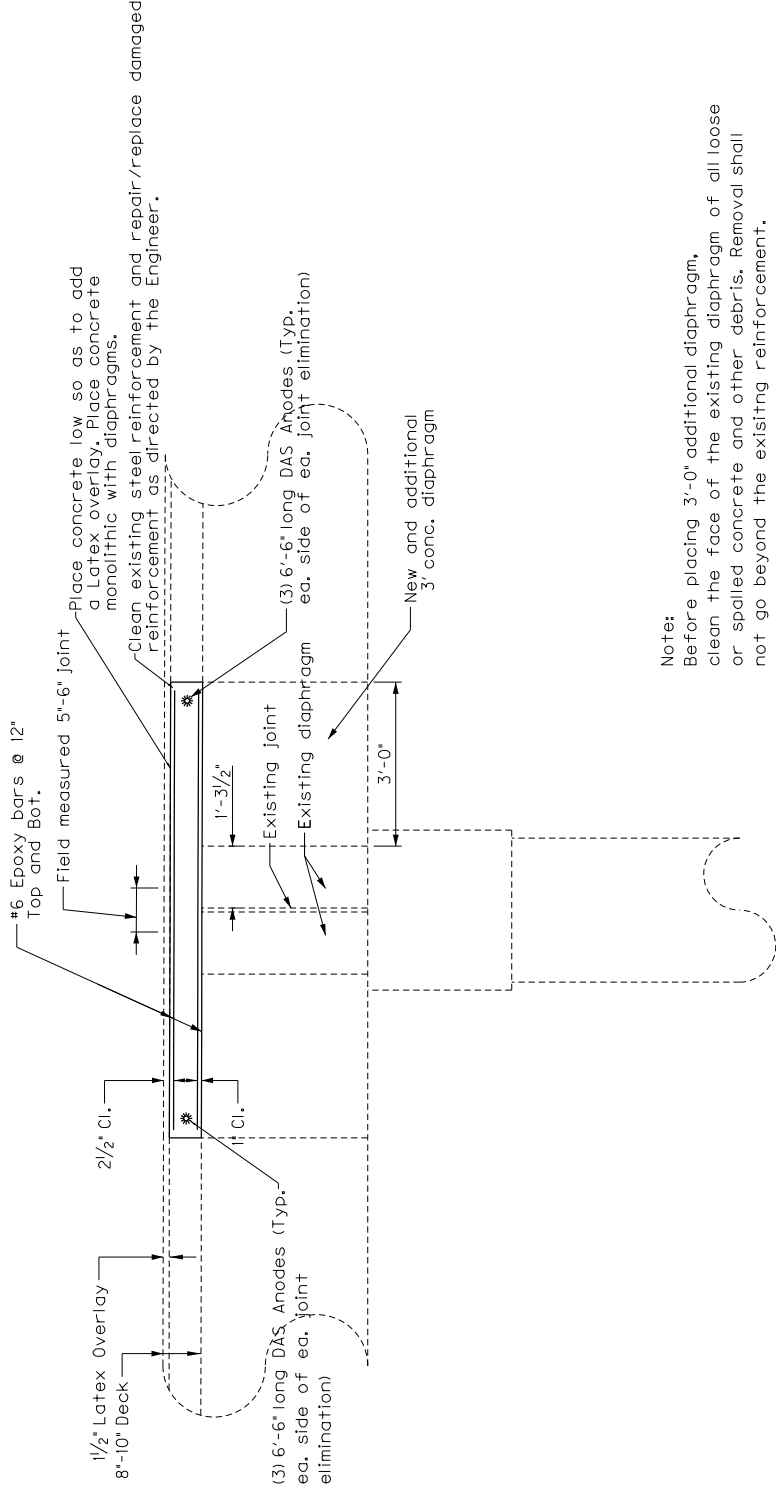

**SECTION AT PIER
 (Pier Encasement Not Shown)**

Note:
 Before placing 3'-0" additional diaphragm, clean the face of the existing diaphragm of all loose or spalled concrete and other debris. Removal shall not go beyond the existing reinforcement. Removal shall be incidental to Class AA Concrete.

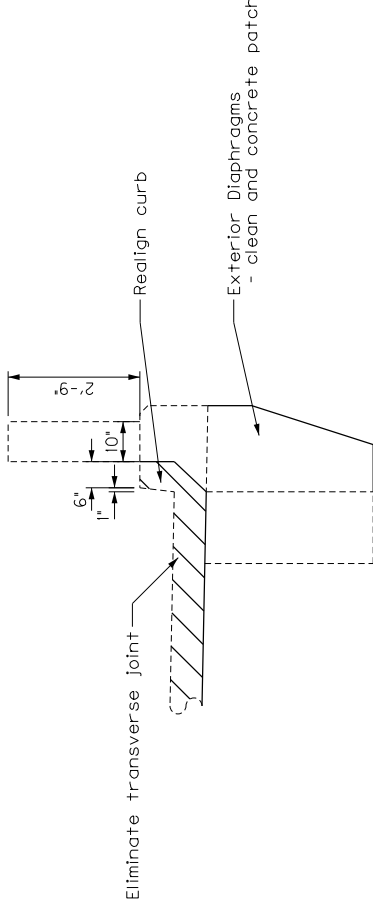

EXISTING SECTION

REVISION	DATE
DESIGNED BY: N. STROOP	CHECKED BY
DETAILED BY: C. BOR	N. STROOP
Commonwealth of Kentucky DEPARTMENT OF HIGHWAYS <small>COUNTY</small> GRANT	
ROUTE KY 22	CROSSING RATTLESNAKE CREEK
ELIMINATE TRANSVERSE JOINT <small>PREPARED BY</small> 	
<small>SHEET NO.</small> 	
<small>DRAWING NO.</small> 27896	

BRIDGE NUMBER

041B00013N

- Notes:
1. Bid Item 3300 "Eliminate Transverse Joint" includes all work and materials to remove the existing joint and replace the deck in the removal area unless otherwise noted.
 2. Class M concrete shall be used to replace the deck and curb in the removal area. Place concrete to match the existing slab/curb dimensions.
 3. All new reinforcement needed for "Eliminating Transverse Joint" shall be epoxy coated and included in the unit price bid for "Eliminate Transverse Joint".
 4. Minimal existing reinforcement is shown for clarity.
 5. Do not disturb rail with the exception of removing 6" of curb and realigning across the joint elimination area.
 6. DAS Anodes to be paid separate from the bid item 3300.

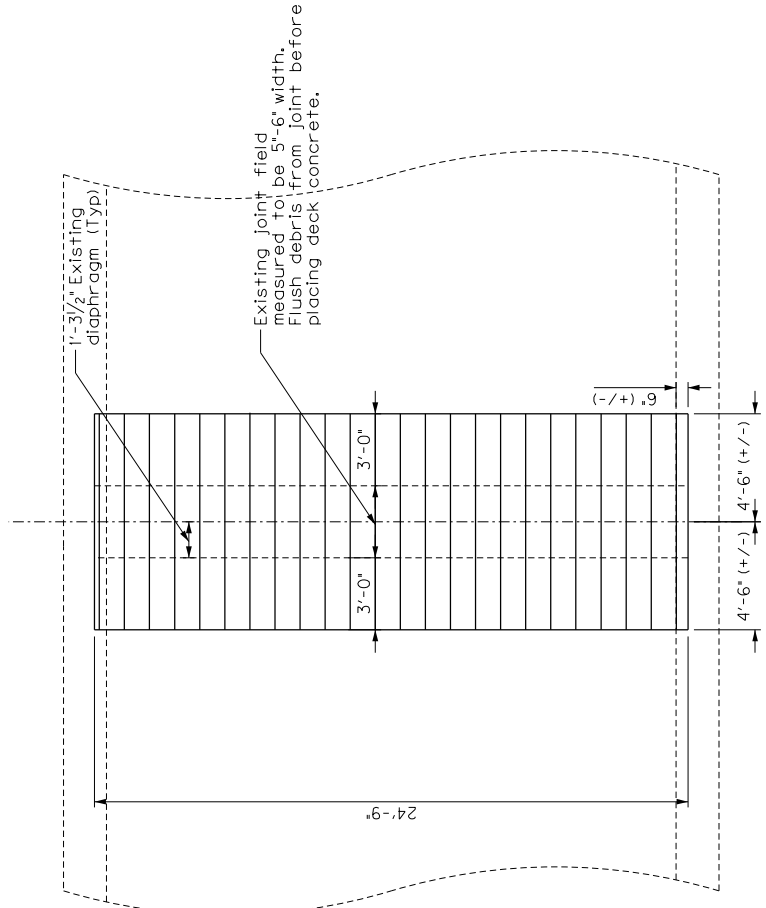

ELIMINATE TRANSVERSE JOINT PLAN

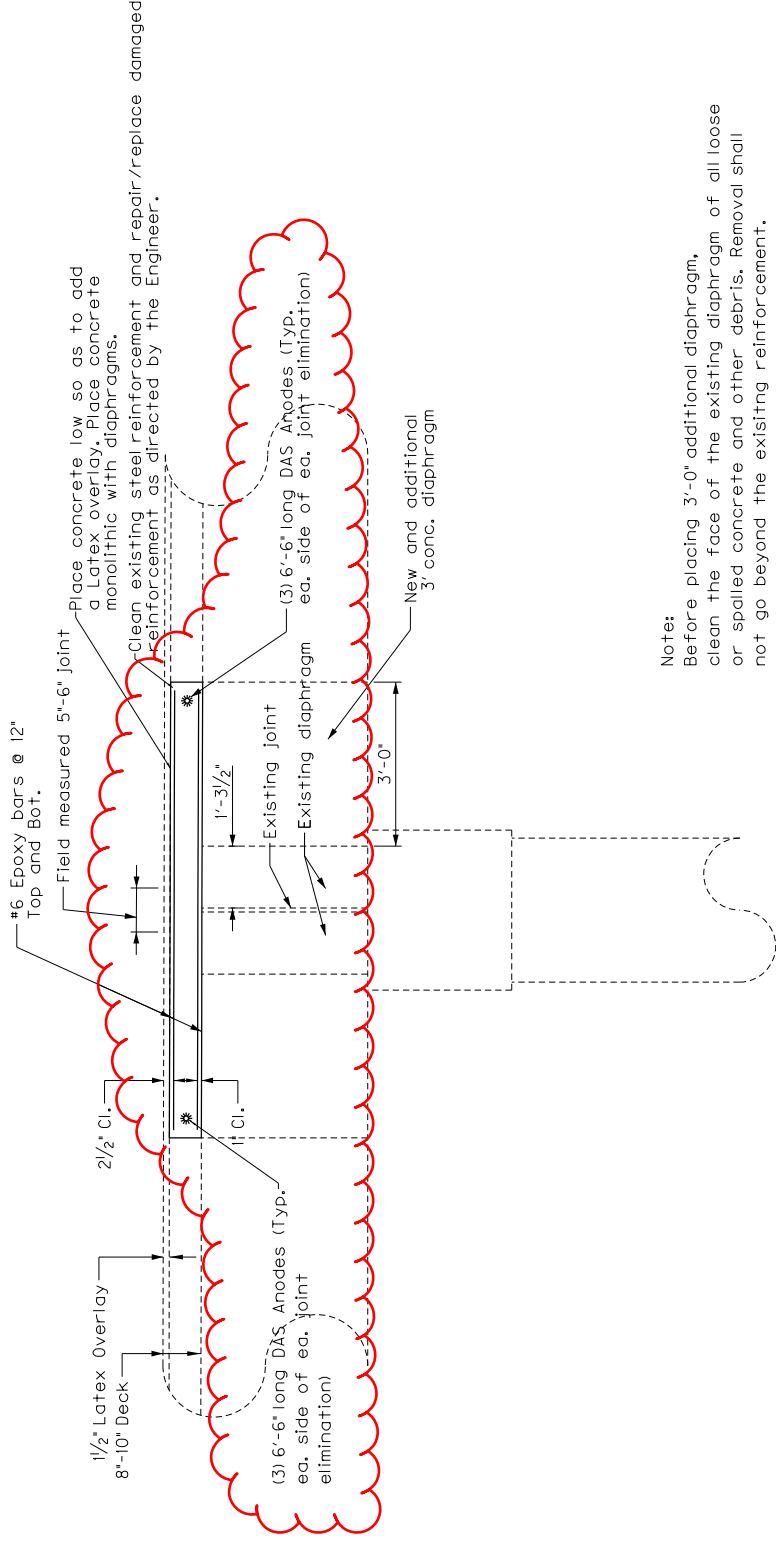

**SECTION AT PIER
 (Pier Encasement Not Shown)**

Note:
 Before placing 3'-0" additional diaphragm, clean the face of the existing diaphragm of all loose or spalled concrete and other debris. Removal shall not go beyond the existing reinforcement. Removal shall be incidental to Class AA Concrete.

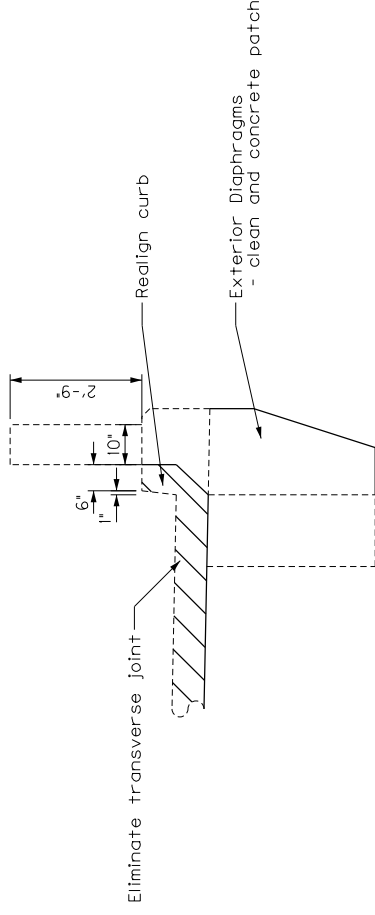

EXISTING SECTION

REVISION	DATE
DATE: 01/18/2019	CHECKED BY
DESIGNED BY: N. STROOP	D. CARPENTER
DETAILED BY: C. BOR	N. STROOP
Commonwealth of Kentucky DEPARTMENT OF HIGHWAYS	
COUNTY GRANT	
ROUTE KY 22	CROSSING RATTLESNAKE CREEK
ELIMINATE TRANSVERSE JOINT	
PREPARED BY	
ABJ	
BRIDGE NUMBER	
041B00013N	
SHEET NO.	DRAWING NO.
56	27896

- Notes:
1. Bid Item 3300 "Eliminate Transverse Joint" includes all work and materials to remove the existing joint and replace the deck in the removal area unless otherwise noted.
 2. Class M concrete shall be used to replace the deck and curb in the removal area. Place concrete to match the existing slab/curb dimensions.
 3. All new reinforcement needed for "Eliminating Transverse Joint" shall be epoxy coated and included in the unit price bid for "Eliminate Transverse Joint".
 4. Minimal existing reinforcement is shown for clarity.
 5. Do not disturb rail with the exception of removing 6" of curb and realigning across the joint elimination area.
 6. DAS Anodes to be paid separate from the bid item 3300.

ELIMINATE TRANSVERSE JOINT PLAN

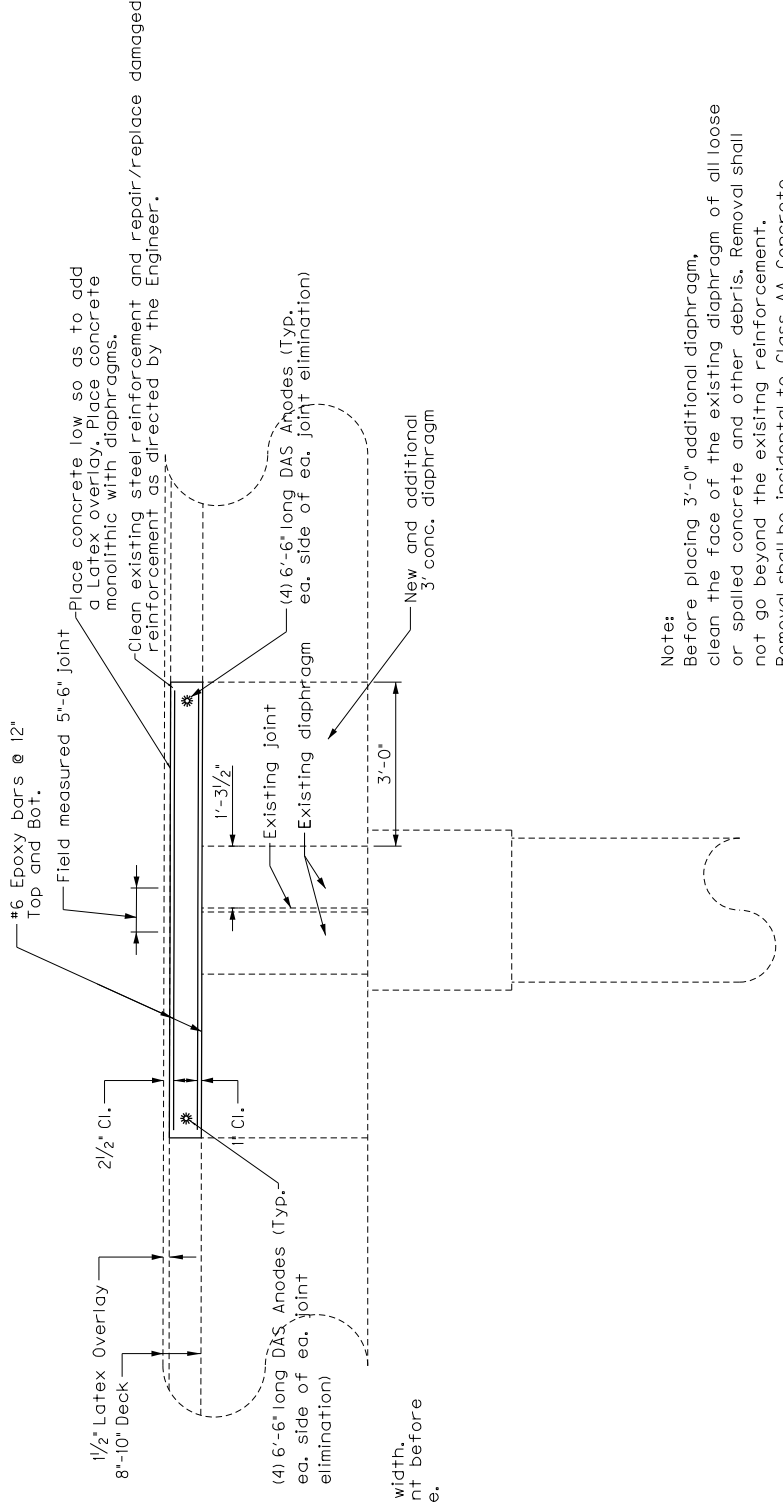
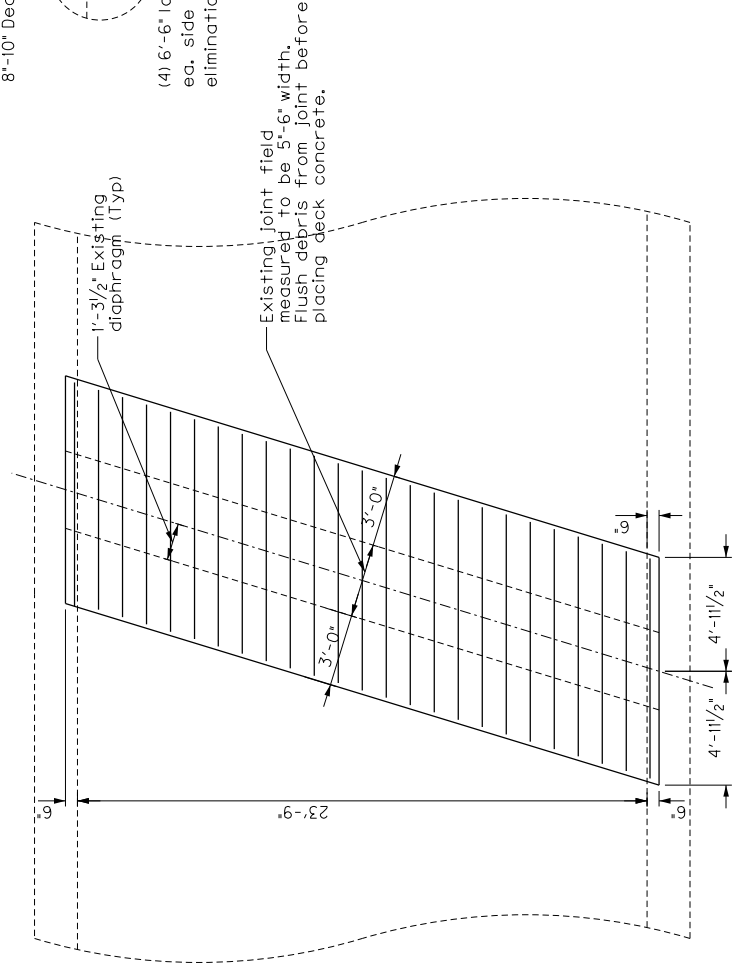

**SECTION AT PIER
 (Pier Encasement Not Shown)**

Note:
 Before placing 3'-0" additional diaphragm, clean the face of the existing diaphragm of all loose or spalled concrete and other debris. Removal shall not go beyond the existing reinforcement. Removal shall be incidental to Class AA Concrete.

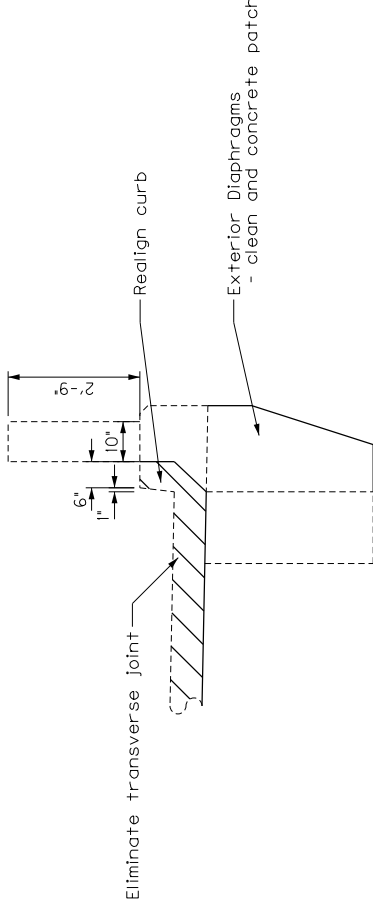

EXISTING SECTION

REVISION	DATE
DATE: 01/18/2019	CHECKED BY
DESIGNED BY: N. STROOP	D. CARPENTER
DETAILED BY: C. BOR	N. STROOP
Commonwealth of Kentucky DEPARTMENT OF HIGHWAYS	
COUNTY GRANT	
ROUTE KY 22	CROSSING EAGLE CREEK
ELIMINATE TRANSVERSE JOINT	
PREPARED BY AEI	SHEET NO. 56
BRIDGE NUMBER 041B00014N	DRAWING NO. 27897

- Notes:
1. Bid Item 3300 "Eliminate Transverse Joint" includes all work and materials to remove the existing joint and replace the deck in the removal area unless otherwise noted.
 2. Class M concrete shall be used to replace the deck and curb in the removal area. Place concrete to match the existing slab/curb dimensions.
 3. All new reinforcement needed for "Eliminating Transverse Joint" shall be epoxy coated and included in the unit price bid for "Eliminate Transverse Joint".
 4. Minimal existing reinforcement is shown for clarity.
 5. Do not disturb rail with the exception of removing 6" of curb and realigning across the joint elimination area.
 6. DAS Anodes to be paid separate from the bid item 3300.

ELIMINATE TRANSVERSE JOINT PLAN

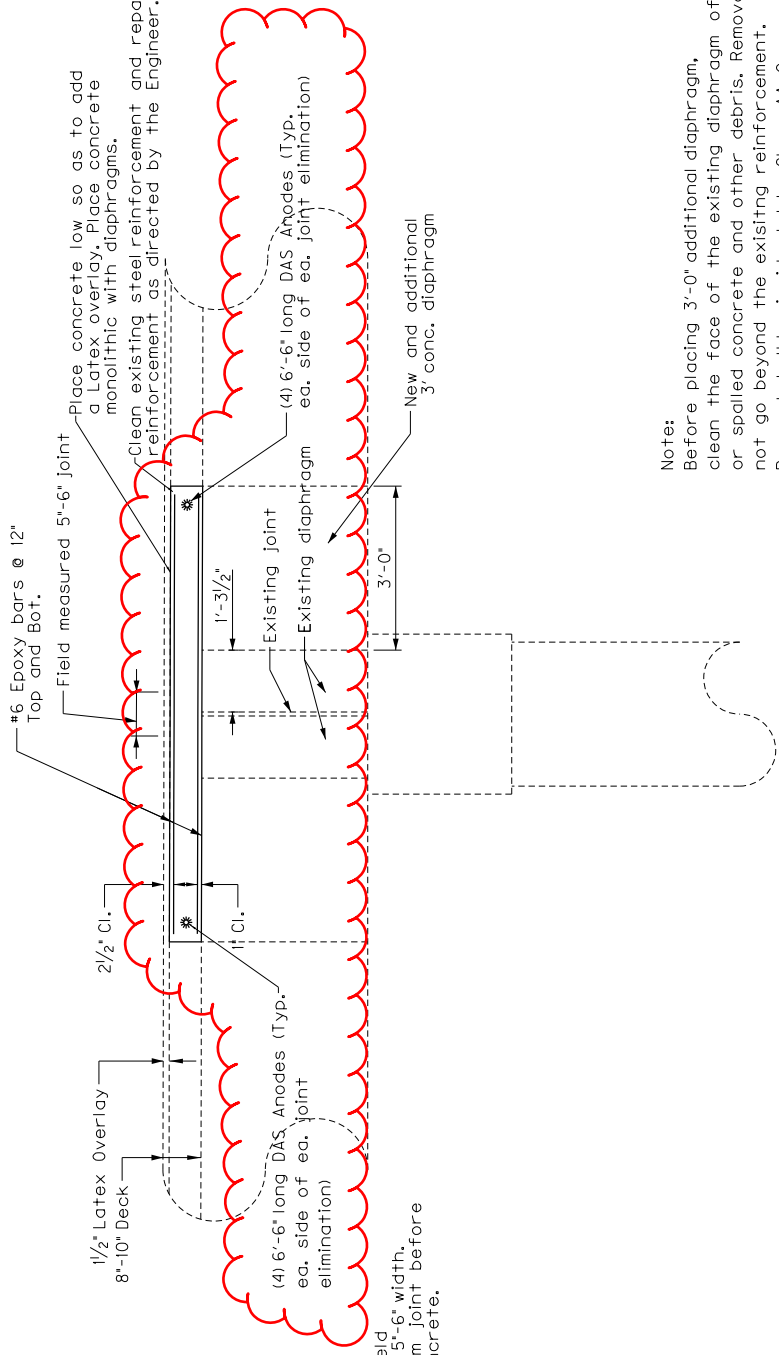
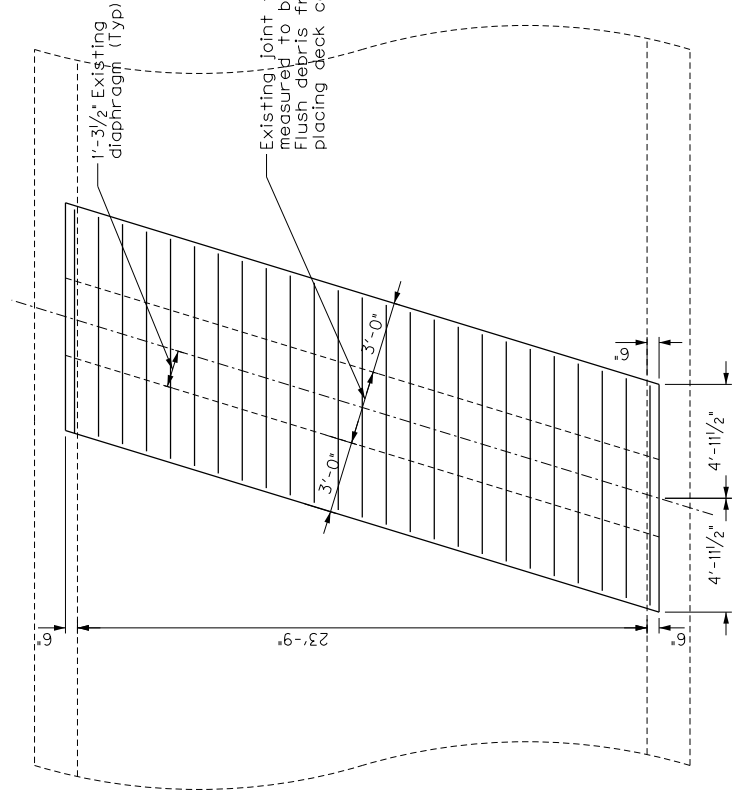

**SECTION AT PIER
 (Pier Encasement Not Shown)**

Note:
 Before placing 3'-0" additional diaphragm, clean the face of the existing diaphragm of all loose or spalled concrete and other debris. Removal shall not go beyond the existing reinforcement. Removal shall be incidental to Class AA Concrete.

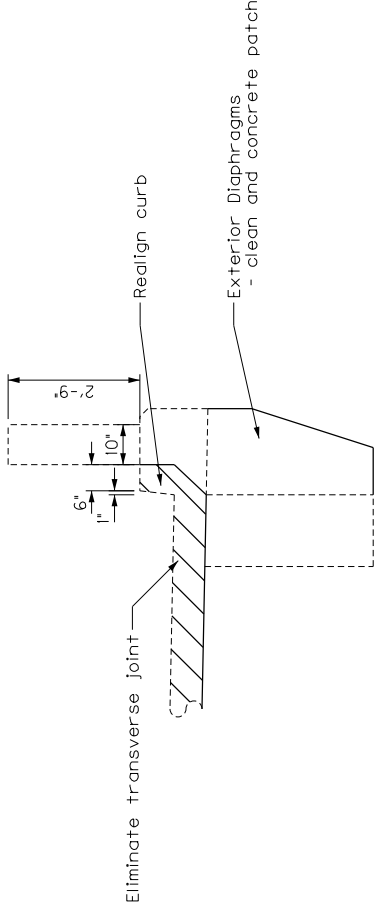

EXISTING SECTION

REVISION	DATE
DATE: 01/18/2019	CHECKED BY
DESIGNED BY: N. STROOP	D. CARPENTER
DETAILED BY: C. BOR	N. STROOP
Commonwealth of Kentucky DEPARTMENT OF HIGHWAYS	
COUNTY GRANT	
ROUTE KY 22	CROSSING EAGLE CREEK
ELIMINATE TRANSVERSE JOINT	
BRIDGE NUMBER 041B00014N	PREPARED BY AEI
SHEET NO. 56 DRAWING NO. 27897	

NOTES:

- Following removal of deck, open area shall be covered with a steel plate during nonworking hours until new concrete is placed. Cost shall be incidental to Eliminate Transverse Joint.
- For dowel detail, see Sheet S4.

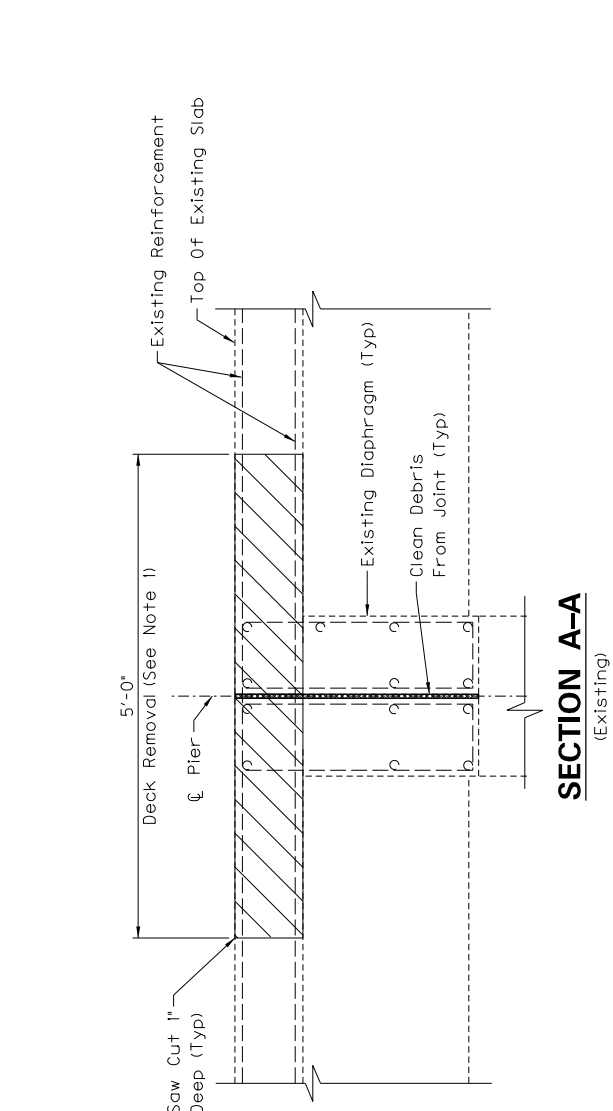

SECTION A-A
(Existing)

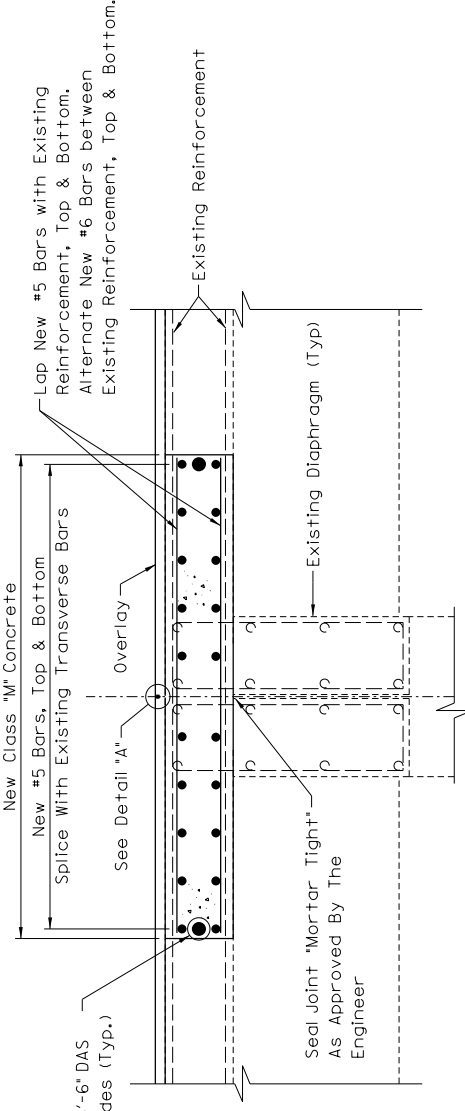

SECTION A-A
(Proposed)

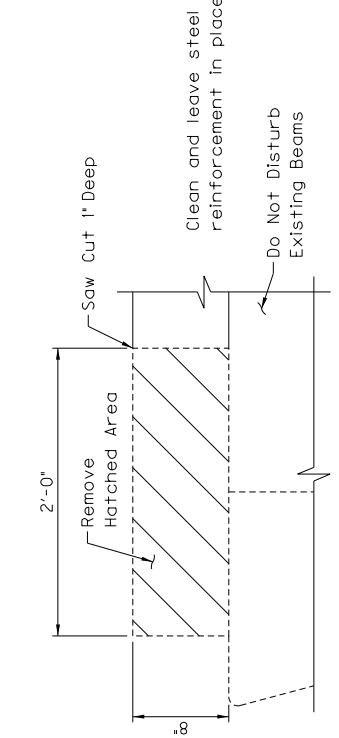

SECTION B-B
(Existing)

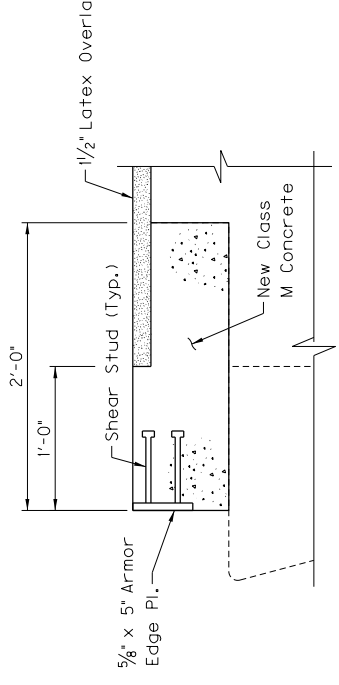

SECTION B-B
(Proposed)

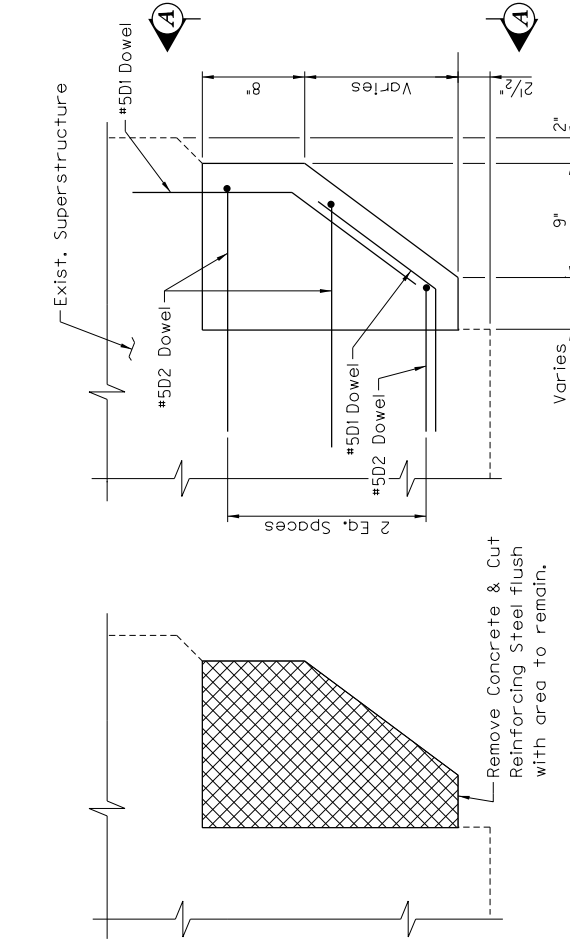

DETAIL "B"
(Existing)

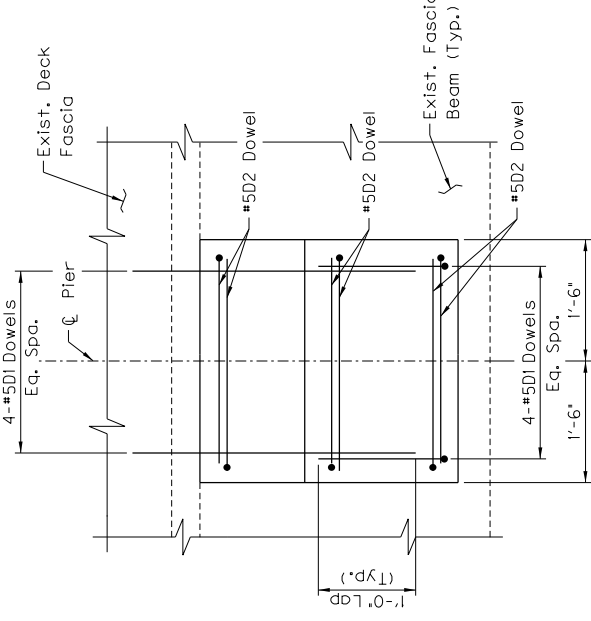

DETAIL "B"
(Proposed)

VIEW A-A

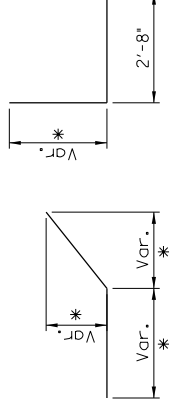

#5D1 Dowel **#5D2 Dowel**

* Field bend/cut bars as needed to maintain details as shown.

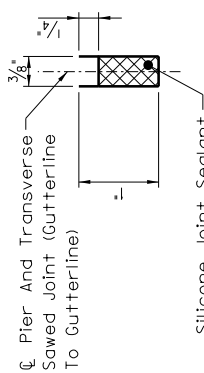

DETAIL "A"

REVISION	DATE
DESIGNED BY: A. Foley	CHECKED BY: T. Baker
DETAILED BY: K. Meichtry	T. Baker
Commonwealth of Kentucky DEPARTMENT OF HIGHWAYS	
COUNTY GRANT	
ROUTE KY 22	CROSSING CLARKS CREEK & BATON ROUGE RD
MISC. DETAILS	
PREPARED BY AECOM	
BRIDGING KENTUCKY	
SHEET NO. S12	DRAWING NO. 27895

BRIDGE NUMBER
041B00011N

NOTES:

- Following removal of deck, open area shall be covered with a steel plate during nonworking hours until new concrete is placed. Cost shall be incidental to Eliminate Transverse Joint.
- For dowel detail, see Sheet S4.

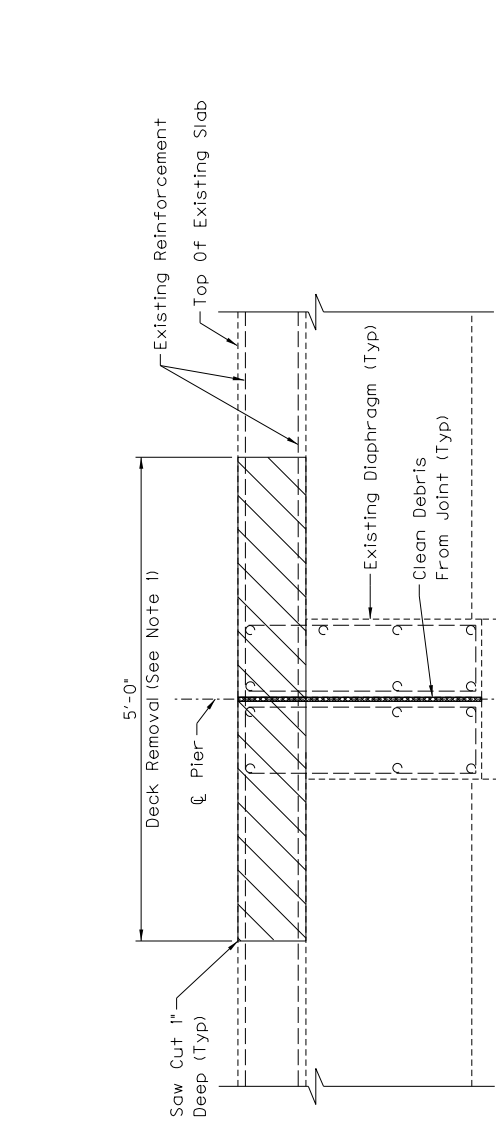

SECTION A-A
(Existing)

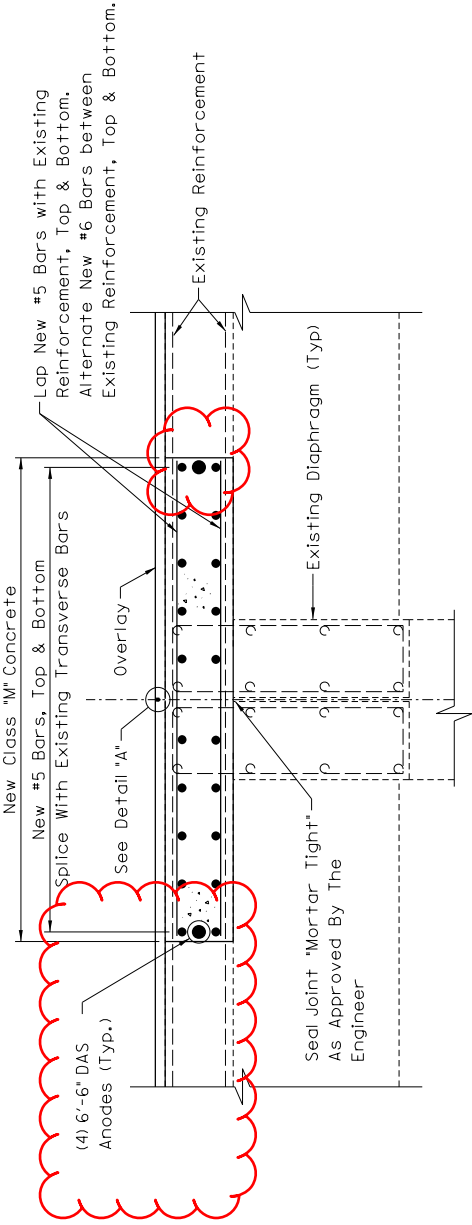

SECTION A-A
(Proposed)

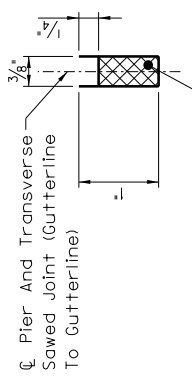

DETAIL "A-A"

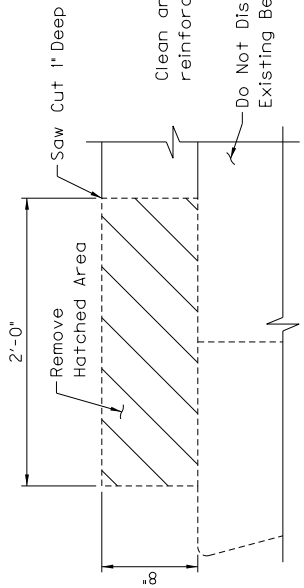

SECTION B-B
(Existing)

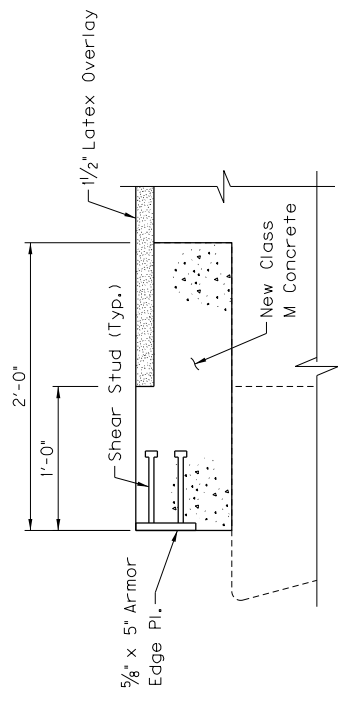

SECTION B-B
(Proposed)

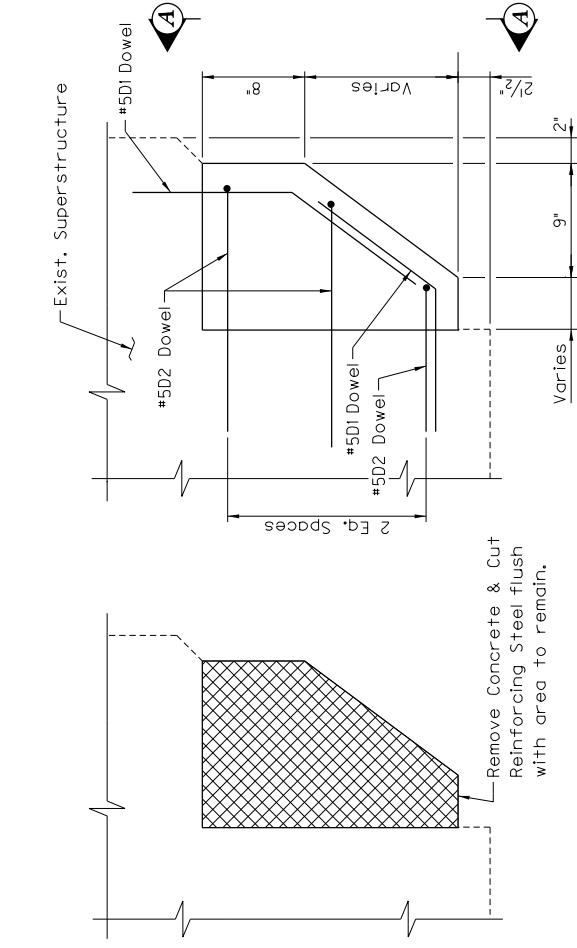

DETAIL "B"
(Existing)

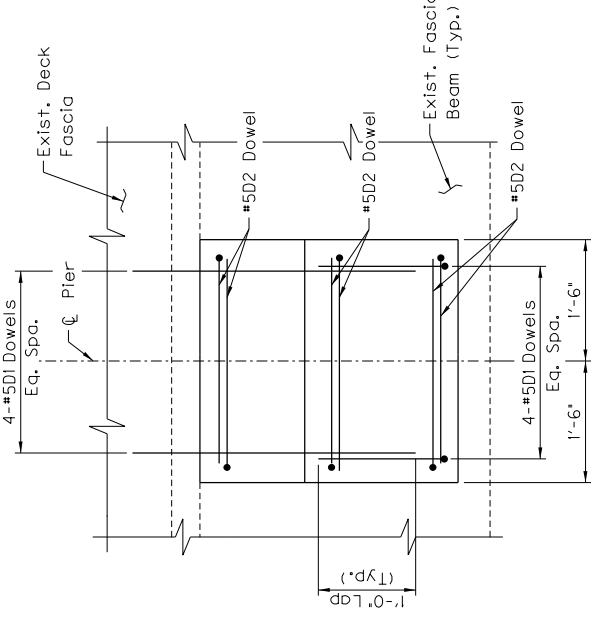

VIEW A-A

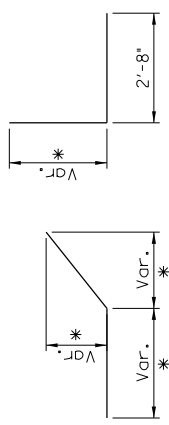

#5D1 Dowel **#5D2 Dowel**

* Field bend/cut bars as needed to maintain details as shown.

REVISION	DATE
DESIGNED BY: A. Foley	CHECKED BY: T. Baker
DATE: 1/18/2019	DETAILED BY: K. Meichtry
T. Baker	
Commonwealth of Kentucky DEPARTMENT OF HIGHWAYS	
COUNTY GRANT	
ROUTE KY 22	CROSSING CLARKS CREEK & BATON ROUGE RD
PREPARED BY MISC. DETAILS	
COUNTY GRANT	
BRIDGING KENTUCKY SHEET NO. S12 DRAWING NO. 27895	
PREPARED BY AECOM	

BRIDGE NUMBER
041B00011N